

Gardinenband - Curtain Tape Highlights



Gerster
GARDINENBÄNDER



Gardinenbänder

Curtain Tapes

Gustav Gerster

Ihr Spezialist für Gardinenbänder

Gardinenbänder bringen die Gardine in gestaltetem Faltenwurf erst richtig zur Geltung und machen sie zu einem echten Blickfang!

Gerster zählt weltweit zu den führenden Gardinenbandherstellern. Modernste Produktionsanlagen ermöglichen eine große Auswahl zu kundenfreundlichen Preisen.

Gerster Gardinenbänder sind die Nr. 1 im deutschen Einzelhandel.

Dieses Buch mit Gardinenband Highlights enthält nur einen kleinen Ausschnitt unseres Sortimentes.

Alle darin enthaltenen Artikel sind sofort ab Lager lieferbar.

Gustav Gerster

your specialist for curtain tapes

With their pleated design, curtain tapes show curtains to their full advantage and make them real eye-catchers!

Gerster is one of the world's leading manufacturers of curtain tapes. State-of-the-art production facilities allow a wide range of collection at customer-friendly prices.

Gerster curtain tapes are the No.1 for retail trade businesses in Germany.

This book with curtain tape highlights includes just a small selection of our assortment.

All articles from this book can be supplied immediately from stock.

Inhalt

Content

Art.	Bezeichnung		Breite	Seiten
	Inhalt	Content		03
	Inhalt	Content		04 - 05
	Newave App			06 - 07
6112	Newave 8 cm		80 mm	08 - 09
61120	Newave black edition 8 cm		80 mm	10 - 11
6113	Newave 6 cm		80 mm	12 - 13
61130	Newave black edition 6 cm		80 mm	14 - 15
6121	Newave 8 cm beschichtet/coated		80 mm	16 - 17
6122	Newave 6 cm beschichtet/coated		80 mm	18 - 19
6135	Twowave 8 cm		50 mm	20 - 21
6136	Twowave 6 cm		50 mm	22 - 23
6308	Harmonica 8 cm		80 mm	24 - 25
6309	Harmonica 6 cm		80 mm	26 - 27
6129	DieWelle	Wave Tape	50 mm	28 - 29
6961	DieWelle	Wave Tape	100 mm	30 - 31
6060	Mini-Welle	The Little Wave Tape	50 mm	32 - 33
6004	1er-Falte	Pleated Tape	90 mm	34 - 35
6005	1er-Falte	Pleated Tape	90 mm	36 - 37
6090	1er-Falte	Pleated Tape	90 mm	38 - 39
6077	1er-Falte	Pleated Tape	150 mm	40 - 41
6410	Duowave	Wave Tape	80 mm	42 - 43
6786	Faltenband	Pleated Tape	50 mm	44 - 45
6780	Faltenband	Pleated Tape	75 mm	46 - 47
6190	Faltenband	Pleated Tape	80 mm	48 - 49
6026	Faltenband	Pleated Tape	150 mm	50 - 51
6195	Faltenband	Pleated Tape	26 mm	52 - 53
6233	Faltenband	Pleated Tape	26 mm	54 - 55
6605	Faltenband	Pleated Tape	28 mm	56 - 57
6973	Royalfalte	Royal Pleated Tape	150 mm	58 - 59

Online Katalog / Nähanleitungen

Online Catalog / Sewing instructions

Online Katalog

Immer aktuell, online
Gardinenband-Katalog
www.gerster.com



Online Catalog

Up to date, online
Curtain tapes-catalog
www.gerster.com

Nähanleitungen

Schulungsvideo
Newave



Sewing instruction

Tutorial video
Newave

Schulungsvideo
Ösenband



Tutorial video
Eyelet tape

Schulungsvideo
Smokfaltenband



Tutorial video
Smocking tape

Schulungsvideo
Wellenfalte



Tutorial video
Wave tape

Schulungsvideo
Flachfaltenband



Tutorial video
Single flat pleat

Inhalt

Content

Art.	Bezeichnung		Breite	Seiten
6948	V-Faltenband	V Pleated Tape	150 mm	60 - 61
6385	Flämische Falte	Pinch Pleated	80 mm	62 - 63
6315	Flachfaltenband	Flat Pleated Tape	26 mm	64 - 65
6760	Flachfaltenband	Flat Pleated Tape	50 mm	66 - 67
6038	Flachfaltenband	Flat Pleated Tape	80 mm	68 - 69
6028	Flachfalte einfach	Single Flat Pleated	150 mm	70 - 71
6835	Rundfaltenband	Round Pleated	75 mm	72 - 73
6952	Schmuckfaltenband	Fancy Pleated	150 mm	74 - 75
6630	Schmuckfaltenband	Fancy Pleated	80 mm	76 - 77
6568	Schmuckfaltenband	Fancy Pleated	50 mm	78 - 79
6169	Schmuckfaltenband	Fancy Pleated	80 mm	80 - 81
6170	Schmuckfaltenband	Fancy Pleated	80 mm	82 - 83
6794	Smokband	Smocking Tape	50 mm	84 - 85
6909	Smokband	Smocking Tape	80 mm	86 - 87
6913	Smokband	Smocking Tape	150 mm	88 - 89
6007	Doppelsmokband	Double Smocking Tape	150 mm	90 - 91
6950	Bleistift-Smokfaltenband	Pencil Pleated Smocking	150 mm	92 - 93
6783	Bleistiftband	Pencil Pleated	75 mm	94 - 95
6505	Plisseeband	Pencil Pleated	50 mm	96 - 97
6739	Universalband	Universal Tape	26 mm	98 - 99
6815	Universalband	Universal Tape	50 mm	100 - 101
6307	Universalband 100% CO	Universal Tape 100% CO	50 mm	102 - 103
6879	Stegband	Slide-on-tape	50 mm	104 - 105
6874	Stegband	Slide-on-tape	100 mm	106 - 107
6905	Stegband mit Smokfalte	Smocking Slide-on-tape	50 mm	108 - 109
6907	Stegband mit Smokfalte	Smocking Slide-on-tape	100 mm	110 - 111
60410	Ösenband	Eyelet Tape	100 mm	112 - 113
60780	Bistro Ösenband	Eyelet Tape Cafe-Style	60 mm	114 - 115
	Zubehör	Accessoires		116 - 120

Jetzt als App erhältlich

Newave App einfach herunterladen für Android im Google Play Store.



Jetzt gibt es den Stoffmengen Kalkulator von Gerster auch als App, mit dem Sie spielend leicht an jedem Ort Stoffmenge, Stoffzugabe, Gleiteranzahl etc. für das Newave Wellenband ausrechnen können.

Für Stoffe die ohne Rapport dekoriert werden sollen nutzen Sie die erste Eingabetaste. Hier werden die vorhanden Markierungen im Band verwendet.

Kalkulator für Stoffe **ohne Rapport**

Bitte geben Sie hierzu folgendes ein:

- 1) gewünschte Zugabe
- 2) gewünschte Vorhangbreite
- 3) Drehgleiterabstand
- 4) Saumzugabe links und rechts



Ergebnis: mögliche Vorhangbreiten, Gleiterzahl, Faltentiefe und benötigte Stoffmenge (Schnittbreite)!
Für Stoffe, die rapportgerecht dekoriert werden sollen, hilft Ihnen die zweite Eingabetaste. Wir empfehlen für einen optimalen Faltenwurf ein Rapport zwischen 24 und 46 cm.

Kalkulator für Stoffe **mit Rapport**

Bitte geben Sie hierzu folgendes ein:

- 1) Rapportbreite
- 2) gewünschte Vorhangbreite
- 3) Drehgleiterabstand
- 4) Saumzugabe links und rechts



Ergebnis: mögliche Vorhangbreiten, Stoffbreite, Gleiteranzahl, Zugabe, benötigte Stoffmenge (Schnittbreite)!

Now available as app

Available for Android in the Google Play Store, for iOS in the App Store, and in the Windows Phone Store!



Our Newave calculator is now also available as app. You can use it to calculate the amount of the needed fabric and gliders.

For fabrics without a pattern repeat please use the first input mask. The regular markings on the tape can be used in this case.

Calculating tool for fabrics **without** pattern repeat

Please enter the following:

- 1) Desired fullness
- 2) Desired curtain width
- 3) Distance between the gliders
- 4) Allowance for the seam on the left and right side

Results: possible curtain widths, amount of gliders, depth of the pleats, needed fabric amount. For fabrics with a certain pattern repeat, please use the second input mask.

We recommend to use a pattern repeat between 24 cm and 46 cm or a perfect fall of the pleats.

Calculating tool for fabrics **with** pattern repeat.

Please enter the following:

- 1) Pattern repeat
- 2) Desired curtain width
- 3) Distance between gliders
- 4) Allowance for the seam on the left and right side

Results: curtain width, fabric width, amount of gliders, fullness, needed fabric amount.



Newave Wellenband 80 mm

Newave Wave Tape 80 mm

Artikel Article	Zugabe Fullness	Faltenabstand Distance between pleats	Rapport Repeat
6112 volltrans.	200/ 250 /280 %	8 cm	16/ 20 /23 cm
6113 volltrans.	200/250/280 %	6 cm	12/15/17 cm
6121 volltrans.	200/250/280 %	8 cm beschichtet / coated	16/20/23 cm
6122 volltrans.	200/250/280 %	6 cm beschichtet / coated	12/15/17 cm

- Für die meisten handelsüblichen Schienen- und Stangensysteme mit Innenlauf.
- Individuelle Zugaben möglich
- Bei auf- oder zugezogener Gardine immer perfekt in Form
- Für Stoffe mit und ohne Rapport
- Für Dekostoffe und Stores geeignet

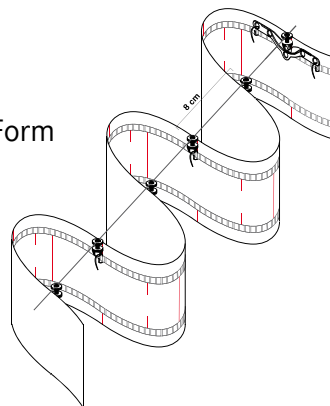

- Suitable for standard curtain rails and rods with internal rail
- Individual additions possible
- Always in perfect form no matter if curtains are opened up or closed
- For fabrics with and without pattern repeat
- Suitable for heavy curtains and stores

Endhaken / end-hook
Art. 14060



Passende Kordeln /
matching glider cords

Gardinenhaken / hook
Art. 14054 oder Art. 14155

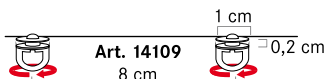
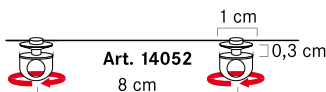

Bremse / stopper
Art. 14143

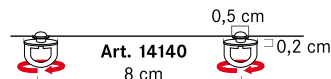
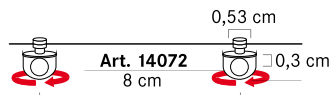
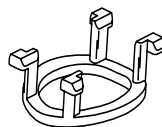



NEUAVE



Stoffmengen-Kalkulator

Mit dem Stoffmengen-Kalkulator können Sie noch einfacher rapportgerecht dekorieren.

Tool for calculating the fabric amount

This calculator helps you to calculate the fabric amount.

Newave Wellenband schwarz 80 mm

Newave Wave Tape black 80 mm

Artikel Article	Zugabe Fullness	Faltenabstand Distance between pleats	Rapport Repeat
61120 schwarz	250 %	8 cm	16/20/23 cm

- Für die meisten handelsüblichen Schienen- und Stangensysteme mit Innenlauf.
- Individuelle Zugaben möglich
- Bei auf- oder zugezogener Gardine immer perfekt in Form
- Für Stoffe mit und ohne Rapport
- Für Dekostoffe und Stores geeignet

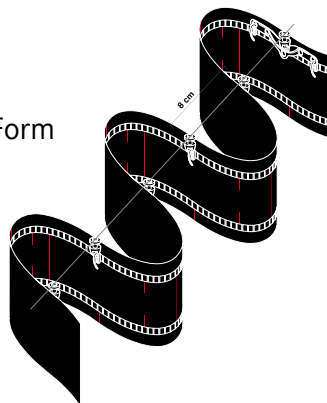

- Suitable for standard curtain rails and rods with internal rail
- Individual additions possible
- Always in perfect form no matter if curtains are opened up or closed
- For fabrics with and without pattern repeat
- Suitable for heavy curtains and stores

Endhaken / end-hook
Art. 14167



Passende Kordeln /
matching glider cords

Gardinenhaken / hook
Art. 14166 Art. 14189

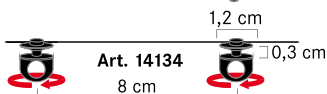
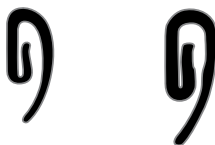

Bremse / brake
Art. 14168

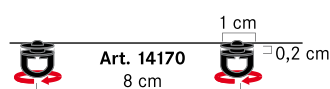



Stoffmengen-Kalkulator

Mit dem Stoffmengen-Kalkulator können Sie noch einfacher rapportgerecht dekorieren.

Tool for calculating the fabric amount

This calculator helps you to calculate the fabric amount.

Newave Wellenband 80 mm

Newave Wave Tape 80 mm

Artikel Article	Zugabe Fullness	Faltenabstand Distance between pleats	Rapport Repeat
6112 volltrans.	200/250/280 %	8 cm	16/20/23 cm
6113 volltrans.	200/250/280 %	6 cm	12/15/17 cm
6121 volltrans.	200/250/280 %	8 cm beschichtet / coated	16/20/23 cm
6122 volltrans.	200/250/280 %	6 cm beschichtet / coated	12/15/17 cm

- Für die meisten handelsüblichen Schienen- und Stangensysteme mit Innenlauf.
- Individuelle Zugaben möglich
- Bei auf- oder zugezogener Gardine immer perfekt in Form
- Für Stoffe mit und ohne Rapport
- Für Dekostoffe und Stores geeignet

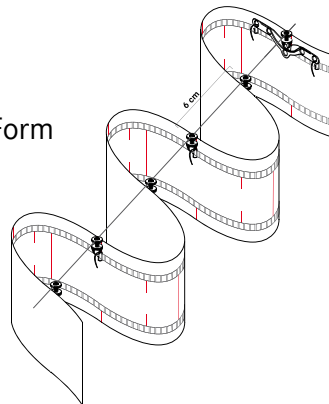

- Suitable for standard curtain rails and rods with internal rail
- Individual additions possible
- Always in perfect form no matter if curtains are opened up or closed
- For fabrics with and without pattern repeat
- Suitable for heavy curtains and stores

Endhaken / end-hook
Art. 14060



Passende Kordeln /
matching glider cords

Gardinenhaken / hook
Art. 14054 oder Art. 14155

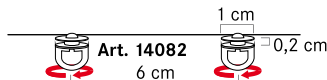
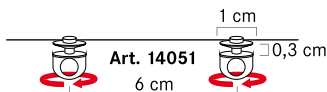

Bremse / stopper
Art. 14143

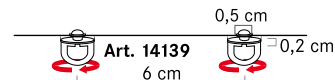
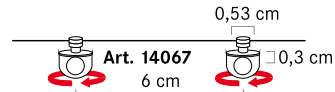
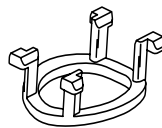



NEUAVE



Stoffmengen-Kalkulator

Mit dem Stoffmengen-Kalkulator können Sie noch einfacher rapportgerecht dekorieren.

Tool for calculating the fabric amount

This calculator helps you to calculate the fabric amount.

Newave Wellenband schwarz 80 mm

Newave Wave Tape black 80 mm

Artikel Article	Zugabe Fullness	Faltenabstand Distance between pleats	Rapport Repeat
61130 schwarz.	200/250/280 %	6 cm	12/15/17 cm

- Für die meisten handelsüblichen Schienen- und Stangensysteme mit Innenlauf.
- Individuelle Zugaben möglich
- Bei auf- oder zugezogener Gardine immer perfekt in Form
- Für Stoffe mit und ohne Rapport
- Für Dekostoffe und Stores geeignet

- Suitable for standard curtain rails and rods with internal rail
- Individual additions possible
- Always in perfect form no matter if curtains are opened up or closed
- For fabrics with and without pattern repeat
- Suitable for heavy curtains and stores

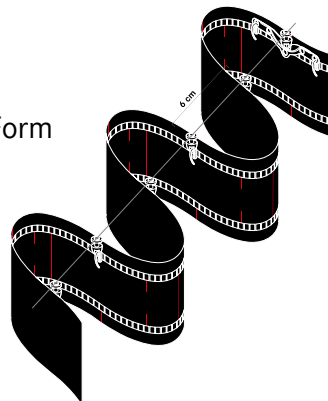

Endhaken / end-hook
Art. 14167



Passende Kordeln /
matching glider cords

Gardinenhaken / hook
Art. 14166 Art. 14189

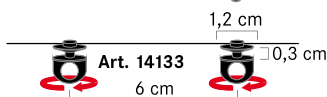
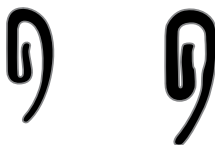

Bremse / brake
Art. 14168

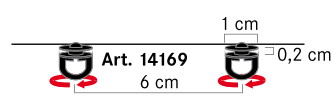



NEUAVE



Stoffmengen-Kalkulator

Mit dem Stoffmengen-Kalkulator können Sie noch einfacher rapportgerecht dekorieren.

Tool for calculating the fabric amount

This calculator helps you to calculate the fabric amount.

Newave Wellenband 80 mm beschichtet

Newave Wave Tape 80 mm coated

Artikel Article	Zugabe Fullness	Faltenabstand Distance between pleats	Rapport Repeat
6112 volltrans.	200/250/280 %	8 cm	16/20/23 cm
6113 volltrans.	200/250/280 %	6 cm	12/15/17 cm
6121 volltrans.	200/ 250 /280 %	8 cm beschichtet / coated	16/ 20 /23 cm
6122 volltrans.	200/250/280 %	6 cm beschichtet / coated	12/15/17 cm

- Für die meisten handelsüblichen Schienen- und Stangensysteme mit Innenlauf.
- Beschichtet zum Aufbügeln und fixieren für leichte Verarbeitung
- Individuelle Zugaben möglich
- Bei auf- oder zugezogener Gardine immer perfekt in Form
- Für Stoffe mit und ohne Rapport
- Für Dekostoffe und Stores geeignet

- Suitable for standard curtain rails and rods with internal rail
- Individual additions possible
- Always in perfect form no matter if curtains are opened up or closed
- For fabrics with and without pattern repeat
- Suitable for heavy curtains and stores
- Suitable for iron-on and/or easy sewing for a perfect form

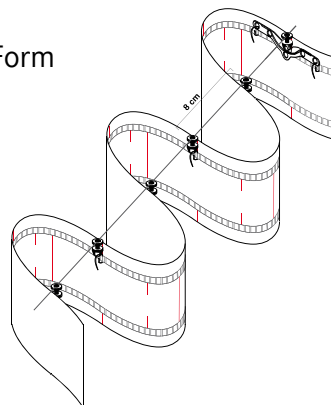

Endhaken / end-hook
Art. 14060



Passende Kordeln /
matching glider cords

Gardinenhaken / hook
Art. 14054 oder Art. 14155

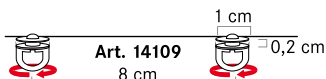
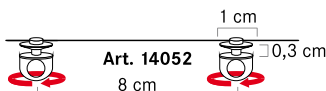

Bremse / stopper
Art. 14143

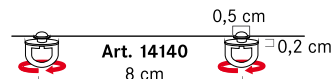
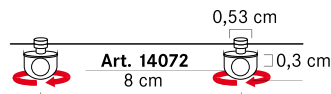
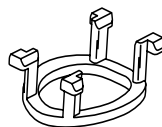



NEUAVE



Stoffmengen-Kalkulator

Mit dem Stoffmengen-Kalkulator können Sie noch einfacher rapportgerecht dekorieren.

Tool for calculating the fabric amount

This calculator helps you to calculate the fabric amount.

Newave Wellenband 80 mm beschichtet

Newave Wave Tape 80 mm coated

Artikel Article	Zugabe Fullness	Faltenabstand Distance between pleats	Rapport Repeat
6112 volltrans.	200/250/280 %	8 cm	16/20/23 cm
6113 volltrans.	200/250/280 %	6 cm	12/15/17 cm
6121 volltrans.	200/250/280 %	8 cm beschichtet / coated	16/20/23 cm
6122 volltrans.	200/ 250 /280 %	6 cm beschichtet / coated	12/ 15 /17 cm

- Für die meisten handelsüblichen Schienen- und Stangensysteme mit Innenlauf.
- Beschichtet zum Aufbügeln und fixieren für leichte Verarbeitung
- Individuelle Zugaben möglich
- Bei auf- oder zugezogener Gardine immer perfekt in Form
- Für Stoffe mit und ohne Rapport
- Für Dekostoffe und Stores geeignet

- Suitable for standard curtain rails and rods with internal rail
- Individual additions possible
- Always in perfect form no matter if curtains are opened up or closed
- For fabrics with and without pattern repeat
- Suitable for heavy curtains and stores
- Suitable for iron-on and/or easy sewing for a perfect form

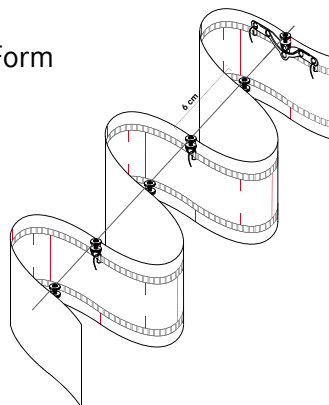

Endhaken / end-hook
Art. 14060



Passende Kordeln /
matching glider cords

Gardinenhaken / hook
Art. 14054 oder Art. 14155

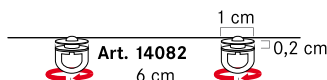
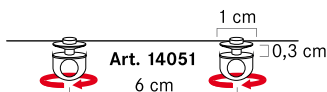

Bremse / stopper
Art. 14143

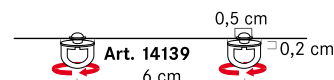
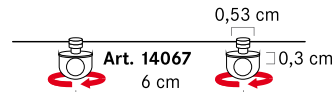
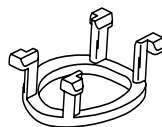



NEUAVE



Stoffmengen-Kalkulator

Mit dem Stoffmengen-Kalkulator können Sie noch einfacher rapportgerecht dekorieren.

Tool for calculating the fabric amount

This calculator helps you to calculate the fabric amount.

Twowave Wellenband 50 mm

Twowave Wave Tape 50 mm

Artikel Article	Zugabe Fullness	Faltenabstand Distance between pleats	Rapport Repeat
6135 volltrans.	200/ 250/ 280%	6 cm	12/ 15/ 17 cm
6136 volltrans.	200/ 250 / 280%	8 cm	16/ 20 /23 cm

- Die perfekte Dekoration für zwei stoffe in einem Band
- Für die meisten handelsüblichen Schienen- und Stangensysteme mit Innenlauf.
- Individuelle Zugaben möglich
- Bei auf- oder zugezogener Gardine immer perfekt in Form
- Für Stoffe mit und ohne Rapport
- Für Dekostoffe und Stores geeignet

- Decorating two fabrics with only one tape is now perfectly easy
- Suitable for standard curtain rails and rods with internal rail
- Individual additions possible
- Always in perfect form no matter if curtains are opened up or closed
- For fabrics with and without pattern repeat
- Suitable for heavy curtains and stores

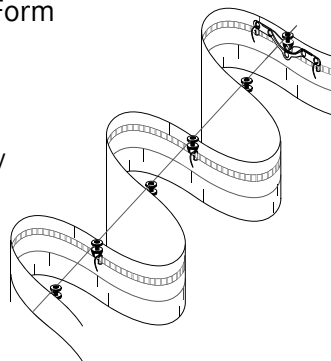

Endhaken / end-hook
Art. 14060



Passende Kordeln /
matching glider cords

Gardinenhaken / hook
Art. 14054 oder Art. 14155

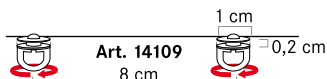
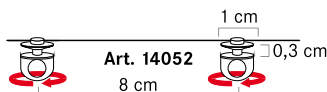

Bremse / stopper
Art. 14143

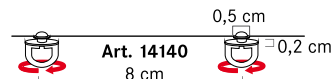
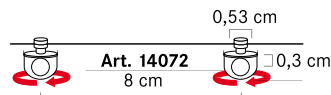
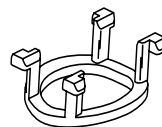



TUOAVE



Stoffmengen-Kalkulator

Mit dem Stoffmengen-Kalkulator können Sie noch einfacher rapportgerecht dekorieren.

Tool for calculating the fabric amount

This calculator helps you to calculate the fabric amount.

Twowave Wellenband 50 mm

Twowave Wave Tape 50 mm

Artikel Article	Zugabe Fullness	Faltenabstand Distance between pleats	Rapport Repeat
6135 volltrans.	200/ 250 / 280%	6 cm	12/ 15 / 17 cm
6136 volltrans.	200/ 250/ 280%	8 cm	16/20/23 cm

- Die perfekte Dekoration für zwei stoffe in einem Band
- Für die meisten handelsüblichen Schienen- und Stangensysteme mit Innenlauf.
- Individuelle Zugaben möglich
- Bei auf- oder zugezogener Gardine immer perfekt in Form
- Für Stoffe mit und ohne Rapport
- Für Dekostoffe und Stores geeignet

- Decorating two fabrics with only one tape is now perfectly easy
- Suitable for standard curtain rails and rods with internal rail
- Individual additions possible
- Always in perfect form no matter if curtains are opened up or closed
- For fabrics with and without pattern repeat
- Suitable for heavy curtains and stores

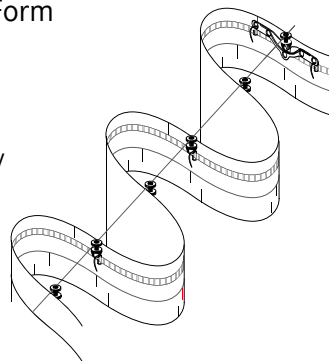

Endhaken / end-hook
Art. 14060



Passende Kordeln /
matching glider cords

Gardinenhaken / hook
Art. 14054 oder Art. 14155

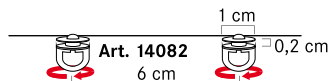
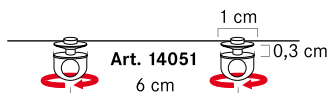

Bremse / stopper
Art. 14143

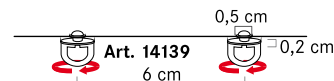
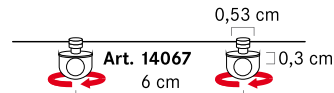
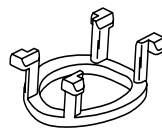



TUOAVE



Stoffmengen-Kalkulator

Mit dem Stoffmengen-Kalkulator können Sie noch einfacher rapportgerecht dekorieren.

Tool for calculating the fabric amount

This calculator helps you to calculate the fabric amount.

Harmonica 80 mm

Harmonica 80 mm

Artikel Article	Zugabe Fullness	Faltenabstand Distance between pleats	Rapport Repeat
6308 volltrans.	250 %	8 cm	40 cm

- Für die meisten handelsüblichen Schienen- und Stangensysteme mit Innenlauf.
- Bei auf- oder zugezogener Gardine immer perfekt in Form
- Für Stoffe mit und ohne Rapport
- Für Dekostoffe und Stores geeignet

- Suitable for standard curtain rails and rods with internal rail
- Always in perfect form no matter if curtains are opened up or closed
- For fabrics with and without pattern repeat
- Suitable for heavy curtains and stores

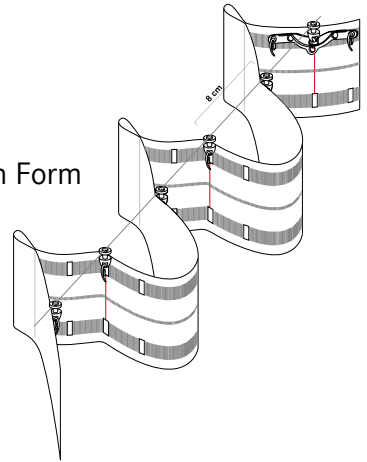

Endhaken / end-hook
Art. 14060



Passende Kordeln /
matching glider cords

Gardinenhaken / hook
Art. 14054 oder Art. 14155

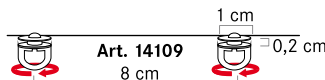
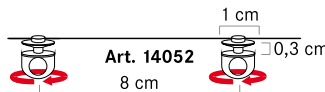

Bremse / stopper
Art. 14143

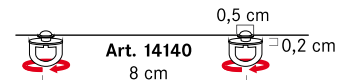
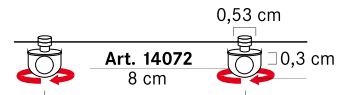
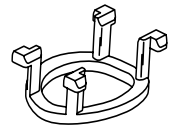



HARMONICA
WELLE



Harmonica 80 mm

Harmonica 80 mm

Artikel Article	Zugabe Fullness	Faltenabstand Distance between pleats	Rapport Repeat
6309 volltrans.	250 %	6 cm	30 cm

- Für die meisten handelsüblichen Schienen- und Stangensysteme mit Innenlauf.
- Bei auf- oder zugezogener Gardine immer perfekt in Form
- Für Stoffe mit und ohne Rapport
- Für Dekostoffe und Stores geeignet

- Suitable for standard curtain rails and rods with internal rail
- Always in perfect form no matter if curtains are opened up or closed
- For fabrics with and without pattern repeat
- Suitable for heavy curtains and stores

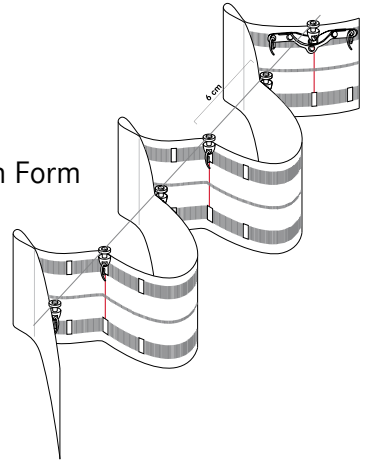

Endhaken / end-hook
Art. 14060



Passende Kordeln /
matching glider cords

Gardinenhaken / hook
Art. 14054 oder Art. 14155

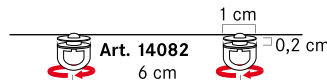
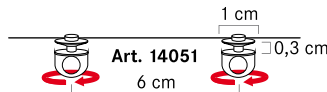

Bremse / stopper
Art. 14143

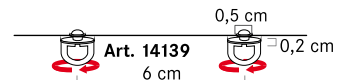
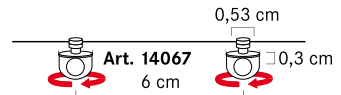
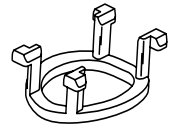



HARMONICA
WELLE



Die Welle, Wellenband 50 mm

The Wave, Wave Tape 50 mm

Artikel Article	Zugabe Fullness	Faltenabstand Distance between pleats	Rapport Repeat
6127 volltrans.	150 %	13,3 cm	20 cm
6128 volltrans.	200 %	12 cm	24 cm
6129 volltrans.	250 %	8 cm	20 cm

- Verwendbar für Schienen und Stangen mit Innenlauf
 - Verwendbar für Schienen und Stangen
 - Bei auf- oder zugezogener Gardine immer perfekt in Form
 - Für leichte oder transparente Stoffe bis mittelschwere Dekostoffe
 - Schnelle Handhabung
 - Ideal für kleine Fenster
-
- Suitable for curtain rails and rods with internal rail
 - Suitable for curtain rails and rods
 - Always in perfect form no matter if curtains are opened up or closed
 - For light and transparent fabrics up to medium-heavy curtains
 - Neat round wave form
 - Easy to handle
 - Ideal for small windows

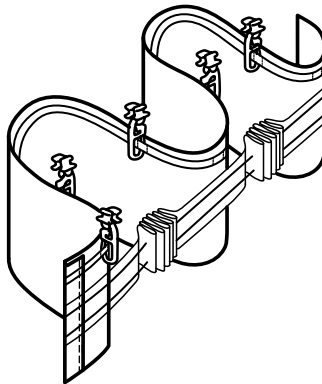



DIE WELLE



Die Welle, Wellenband 100 mm

The Wave, Wave Tape 100 mm

Artikel Article	Zugabe Fullness	Faltenabstand Distance between pleats	Rapport Repeat
6011 volltrans.	150 %	13,3 cm	20 cm
6985 volltrans.	125 %	16 cm	20 cm
6032 volltrans.	180 %	12 cm	23 cm
6961 volltrans.	250 %	8 cm	20 cm
6999 volltrans.	200 %	12 cm	24 cm

- Verwendbar für Schienen und Stangen mit Innenlauf
- Verwendbar für Schienen und Stangen (bis \varnothing 30 mm)
- Bei auf- oder zugezogener Gardine immer perfekt in Form
- Mit vertikalen Stegen für Stangeneinschub
- Für leichte oder transparente Stoffe bis mittelschwere Dekostoffe
- Schnelle Handhabung

- Suitable for curtain rails and rods with internal rail
- Suitable for curtain rails and rods (up to \varnothing 30 mm)
- Always in perfect form no matter if curtains are opened up or closed
- With vertical rack for rod insertion
- For light and transparent fabrics up to medium-heavy curtains
- Easy to handle

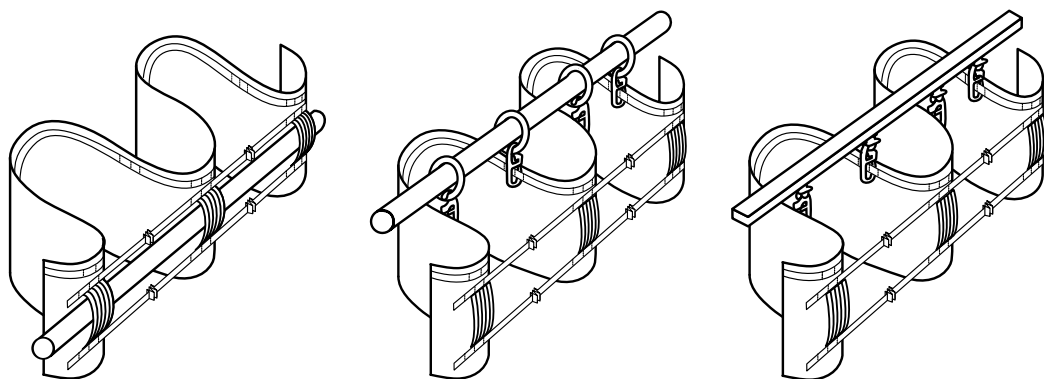



DIE WELLE



Die Mini-Welle 50 mm

The Little Wave Tape 50 mm

Artikel Article	Zugabe Fullness	Faltenabstand Distance between pleats	Rapport Repeat
6060 volltrans.	250 %	2,4 cm	6 cm
6061 volltrans.	180 %	3,3 cm	6 cm

- Verwendbar für Schienen und Stangen mit Innenlauf
 - Verwendbar für Schienen und Stangen
 - Für Stoffe mit und ohne Rapport
 - Für leichte oder transparente Stoffe bis mittelschwere Dekostoffe
 - Ideal für kleine Fenster
-
- Suitable for curtain rails and rods with internal rail
 - Suitable for curtain rails and rods
 - For fabrics with and without pattern repeat
 - For light and transparent fabrics up to medium-heavy curtains
 - Ideal for small windows

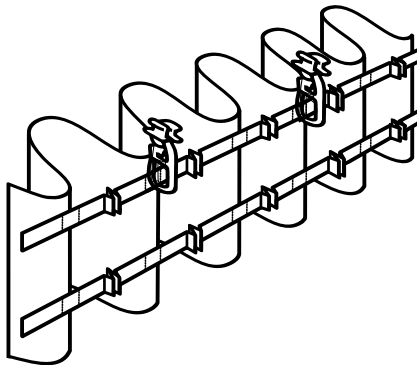



1er Falte Faltenband 90 mm

Pleated Tape 90 mm

Artikel Article	Zugabe Fullness	Faltenabstand Distance between pleats	Rapport Repeat
6004 volltrans.	200 %	9 cm	18 cm
6005 volltrans.	250 %	9 cm	22 cm
6149 volltrans.	150 %	12 cm	18 cm

- Verwendbar für Schienen und Stangen mit Innenlauf
- Verwendbar für Schienen und Stangen
- Für Stoffe ohne Rapport
- Für leichte oder transparente Stoffe bis mittelschwere Dekostoffe
- Bei auf- oder zugezogener Gardine immer perfekt in Form

- Suitable for curtain rails and rod with internal rail
- Suitable for curtain rails and rods
- For fabrics without pattern repeat
- For light and transparent fabrics up to medium-heavy curtains
- Always in perfect form no matter if curtains are opened up or closed

Variante 1
version 1

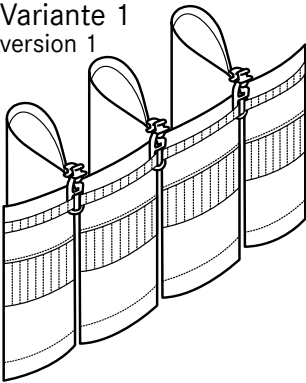

Variante 2
version 2

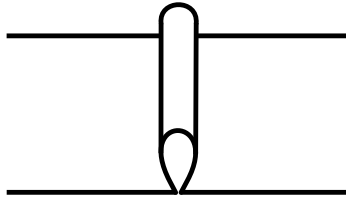
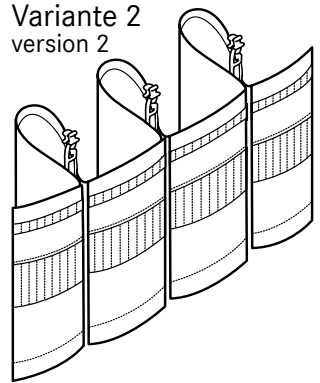

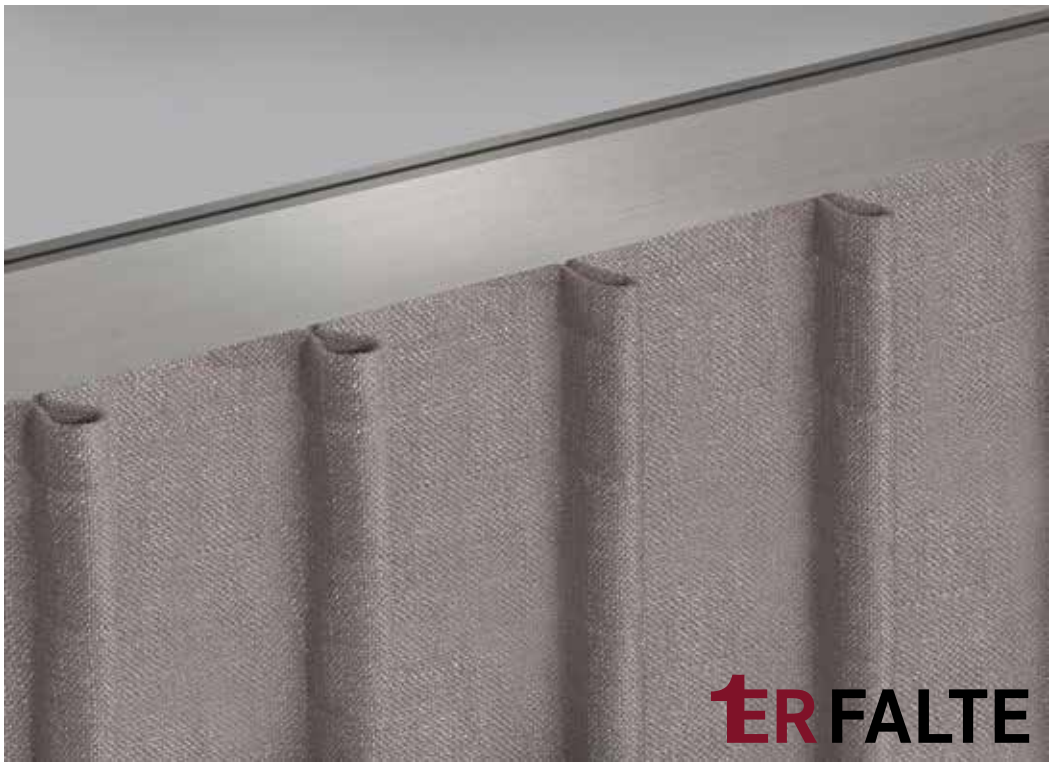

1er Falte Faltenband 90 mm

Pleated Tape 90 mm

Artikel Article	Zugabe Fullness	Faltenabstand Distance between pleats	Rapport Repeat
6004 transparent	200 %	9 cm	18 cm
6005 transparent	250 %	9 cm	22 cm
6149 transparent	150 %	12 cm	18 cm

- Verwendbar für Schienen und Stangen mit Innenlauf
- Verwendbar für Schienen und Stangen
- Für Stoffe ohne Rapport
- Für leichte oder transparente Stoffe bis mittelschwere Dekostoffe
- Bei auf- oder zugezogener Gardine immer perfekt in Form

- Suitable for curtain rails and rod with internal rail
- Suitable for curtain rails and rods
- For fabrics without pattern repeat
- For light and transparent fabrics up to medium-heavy curtains
- Always in perfect form no matter if curtains are opened up or closed

Variante 1
version 1

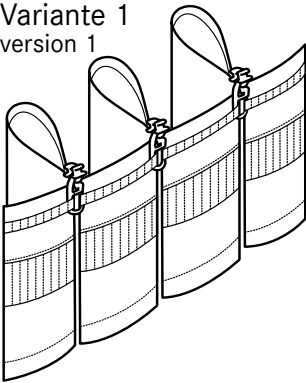

Variante 2
version 2

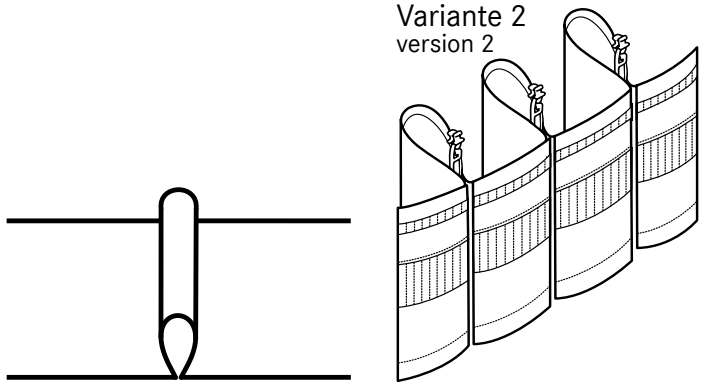



ER FALTE



1er Falte Faltenband 90 mm

Pleated Tape 90 mm

Artikel Article	Zugabe Fullness	Faltenabstand Distance between pleats	Rapport Repeat
6090 weiß/white	250 %	9 cm	22 cm
6089 weiß/white	200 %	9 cm	18 cm
6970 volltrans.	250 %	9 cm	22 cm
6969 volltrans.	200 %	9 cm	18 cm

- Verwendbar für Schienen und Stangen mit Innenlauf
- Verwendbar für Schienen und Stangen
- Für Stoffe ohne Rapport
- Für leichte oder transparente Stoffe bis mittelschwere Dekostoffe
- Bei auf- oder zugezogener Gardine immer perfekt in Form

- Suitable for curtain rails and rod with internal rail
- Suitable for curtain rails and rods
- For fabrics without pattern repeat
- For light and transparent fabrics up to medium-heavy curtains
- Always in perfect form no matter if curtains are opened up or closed

Variante 1
version 1

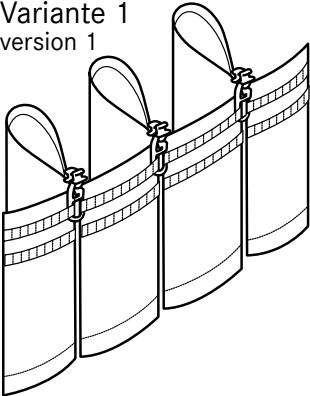

Variante 2
version 2

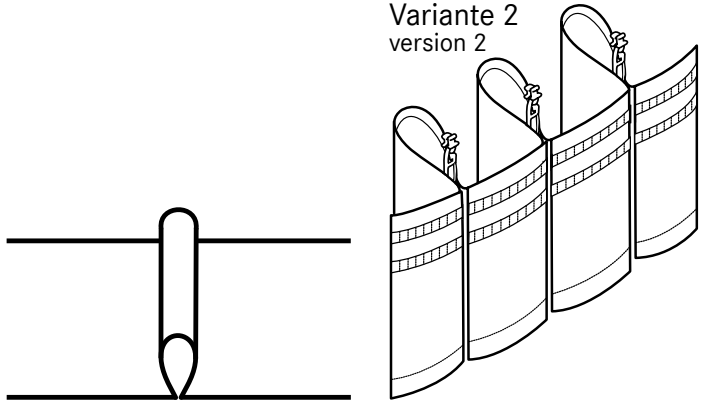

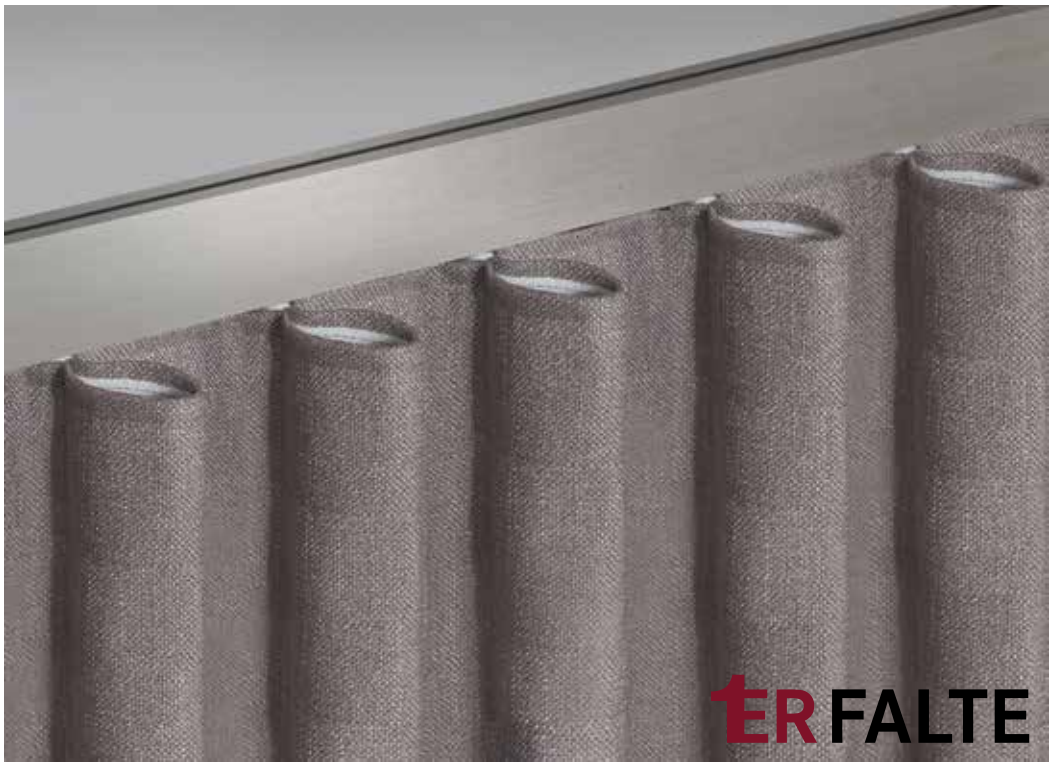

ER FALTE



1er Falte Faltenband 150 mm

Pleated Tape 150 mm

Artikel Article	Zugabe Fullness	Faltenabstand Distance between pleats	Rapport Repeat
6076 volltrans.	200 %	9 cm	18 cm
6077 volltrans.	250 %	9 cm	22,5 cm

- Verwendbar für Schienen und Stangen mit Innenlauf
- Verwendbar für Schienen und Stangen
- Für leichte oder transparente Stoffe bis mittelschwere Dekostoffe
- Für Stoffe ohne Rapport
- Bei auf- oder zugezogener Gardine immer perfekt in Form

- Suitable for curtain rails and rods with internal rail
- Suitable for curtain rails and rods
- For light and transparent fabrics up to medium-heavy curtains
- For fabrics without pattern repeat
- Always in perfect form no matter if curtains are opened up or closed

Variante 1
version 1

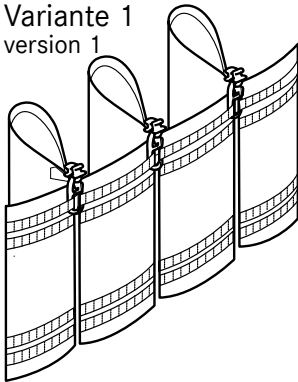

Variante 2
version 2

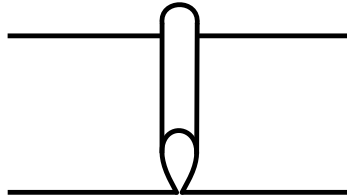
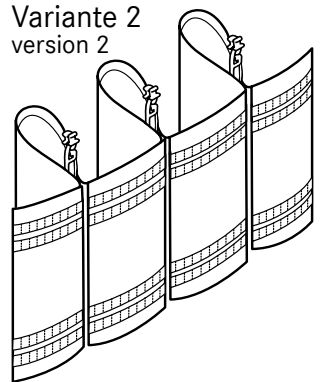

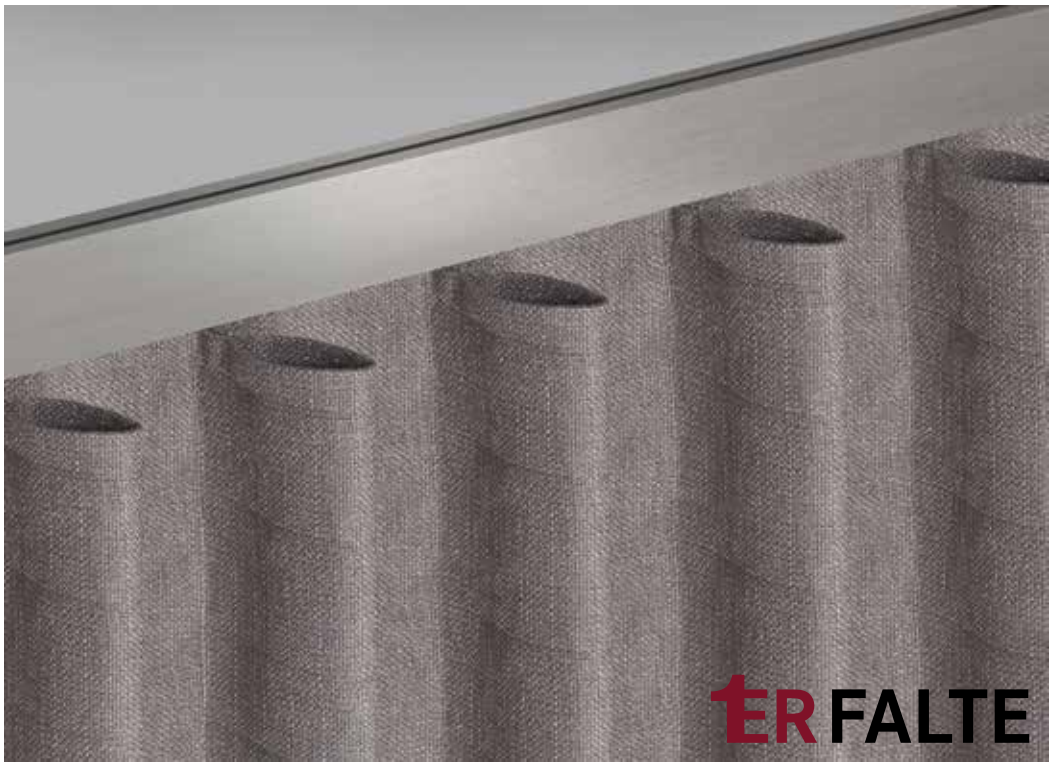

Duowave Wellenband 80 mm

Duowave Wave Tape 80 mm

Artikel Article	Zugabe Fullness	Faltenabstand Distance between pleats	Rapport Repeat
6410 volltransparent	200 %	12 cm	24 cm
64100 Fb.0019 schwarz	200 %	12 cm	24 cm
6414 volltransparent	200 %	12 cm beschichtet/coated	24 cm

- Für die meisten handelsüblichen Schienen- und Stangensysteme mit Innenlauf
- Beschichtet zum Aufbügeln und fixieren für leichte Verarbeitung
- Bei auf- oder zugezogener Gardine immer perfekt in Form
- Für Stoffe ohne Rapport
- Für leichte oder transparente Stoffe bis mittelschwere Dekostoffe
- Suitable for standard curtain rails and rods with internal rail
- Suitable for iron-on and/or easy sewing for a perfect form
- Always in perfect form no matter if curtains are opened up or closed
- For fabrics without pattern repeat
- For light and transparent fabrics up to medium-heavy curtains

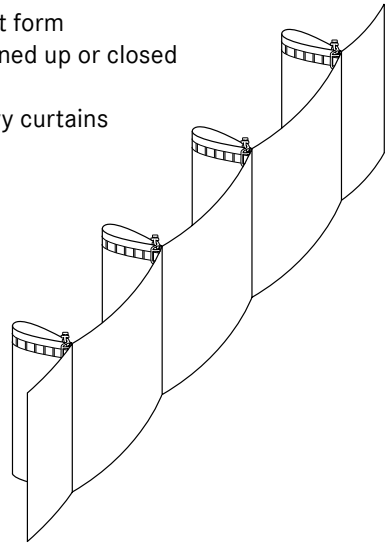
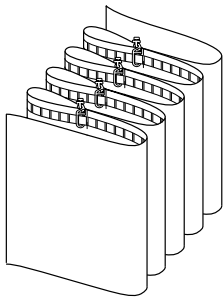



Die Falten zeigen nur nach hinten und das Band bleibt auf der Vorderseite fast flach.
The wrinkles only show towards the back and the ribbon remains flat on the front side.

Faltenband 50 mm

Pleated Tape 50 mm

Artikel Article	Zugabe Fullness	Faltenzahl Number of pleats	Faltenabstand Distance between pleats	Rapport Repeat
6785 volltrans.	300 %	4	8 cm	24 cm
6786 volltrans.	250 %	3	8 cm	20 cm
6787 volltrans.	200 %	2	8 cm	16 cm
6930 volltrans.	200 %	3	10 cm	20 cm
6102 volltrans.	150 %	1	8 cm	12 cm

- Verwendbar für Schienen und Stangen mit Innenlauf
- Verwendbar für Schienen und Stangen
- Für Stoffe ohne Rapport
- Für leichte oder transparente Stoffe bis mittelschwere Dekostoffe
- Bei auf- oder zugezogener Gardine immer perfekt in Form

- Suitable for curtain rails and rods with internal rail
- Suitable for curtain rails and rods
- For fabrics without pattern repeat
- For light and transparent fabrics up to medium-heavy curtains
- Always in perfect form no matter if curtains are opened up or closed

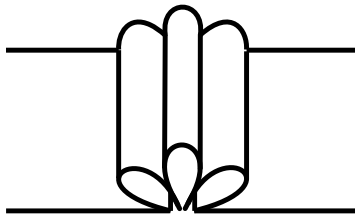



Faltenband 75 mm

Pleated Tape 75 mm

Artikel Article	Zugabe Fullness	Faltenzahl Number of pleats	Faltenabstand Distance between pleats	Rapport Repeat
6780 volltrans.	300 %	4	8 cm	24 cm
6781 volltrans.	250 %	3	8 cm	20 cm
6779 volltrans.	200 %	2	8 cm	16 cm

- Verwendbar für Schienen und Stangen mit Innenlauf
- Verwendbar für Schienen und Stangen
- Für Stoffe mit und ohne Rapport
- Für leichte oder transparente Stoffe bis mittelschwere Dekostoffe
- Bei auf- oder zugezogener Gardine immer perfekt in Form

- Suitable for curtain rails and rods with internal rail
- Suitable for curtain rails and rods
- For fabrics with and without pattern repeat
- For light and transparent fabrics up to medium-heavy curtains
- Always in perfect form no matter if curtains are opened up or closed

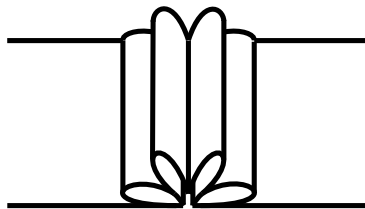



Faltenband 80 mm

Pleated Tape 80 mm

Artikel Article	Zugabe Fullness	Faltenzahl Number of pleats	Faltenabstand Distance between pleats	Rapport Repeat
6190 volltrans.	250 %	4	12 cm	30 cm
6189 volltrans.	200 %	3	15 cm	30 cm
6188 volltrans.	150 %	2	15 cm	22,5 cm
6240 volltrans.	300 %	5	12 cm	36 cm
6321 volltrans.	200 %	1	12 cm	24 cm

- Verwendbar für Schienen und Stangen mit Innenlauf
- Verwendbar für Schienen und Stangen
- Für Dekostoffe und Stores geeignet
- Bei auf- oder zugezogener Gardine immer perfekt in Form
- Suitable for curtain rails and rods with internal rail
- Suitable for curtain rails and rods
- Suitable for heavy curtains and stores
- Always in perfect form no matter if curtains are opened up or closed

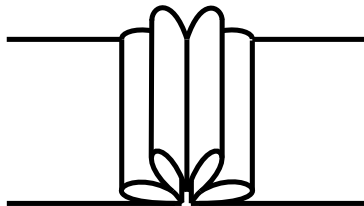



Faltenband 150 mm

Pleated Tape 150 mm

Artikel Article	Zugabe Fullness	Faltenzahl Number of pleats	Faltenabstand Distance between pleats	Rapport Repeat
6025 volltrans.	300 %	5	12 cm	36 cm
6026 volltrans.	250 %	4	12 cm	30 cm
6027 volltrans.	200 %	3	15 cm	30 cm
6984 volltrans.	150 %	2	15 cm	22,5 cm

- Verwendbar für Schienen und Stangen mit Innenlauf
- Verwendbar für Schienen und Stangen
- Für Dekostoffe und Stores geeignet
- Bei auf- oder zugezogener Gardine immer perfekt in Form
- Suitable for curtain rails and rods with internal rail
- Suitable for curtain rails and rods
- Suitable for heavy curtains and stores
- Always in perfect form no matter if curtains are opened up or closed

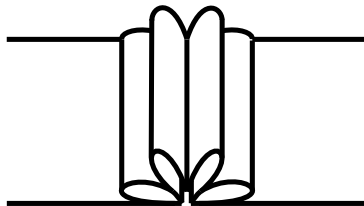



Faltenband 26 mm

Pleated Tape 26 mm

Artikel Article	Zugabe Fullness	Faltenzahl Number of pleats	Faltenabstand Distance between pleats	Rapport Repeat
6195 weiß/white	300 %	4	8 cm	24 cm
6266 weiß/white	270 %	3	8 cm	21,5 cm
6233 weiß/white	250 %	3	8 cm	20 cm
6283 weiß/white	200 %	2	8 cm	16 cm
6202 weiß/white	300 %	4	6 cm	18 cm
6224 weiß/white	300 %	7	10 cm	30 cm
6231 weiß/white	250 %	5	10 cm	25 cm
6199 weiß/white	220 %	3	10 cm	22 cm

- Verwendbar für Schienen und Stangen mit Innenlauf
- Verwendbar für Schienen und Stangen
- Für Stoffe ohne Rapport
- Für leichte oder transparente Stoffe bis mittelschwere Dekostoffe
- Bei auf- oder zugezogener Gardine immer perfekt in Form
- Ideal für kleine Fenster

- Suitable for curtain rails and rods with internal rail
- Suitable for curtain rails and rods
- For fabrics without pattern repeat
- For light and transparent fabrics up to medium-heavy curtains
- Always in perfect form no matter if curtains are opened up or closed
- Ideal for small windows

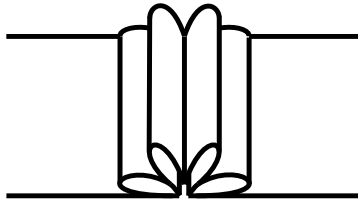



Faltenband 26 mm

Pleated Tape 26 mm

Artikel Article	Zugabe Fullness	Faltenzahl Number of pleats	Faltenabstand Distance between pleats	Rapport Repeat
6195 weiß/white	300 %	4	8 cm	24 cm
6266 weiß/white	270 %	3	8 cm	21,5 cm
6233 weiß/white	250 %	3	8 cm	20 cm
6283 weiß/white	200 %	2	8 cm	16 cm
6202 weiß/white	300 %	4	6 cm	18 cm
6224 weiß/white	300 %	7	10 cm	30 cm
6231 weiß/white	250 %	5	10 cm	25 cm
6199 weiß/white	220 %	3	10 cm	22 cm

- Verwendbar für Schienen und Stangen mit Innenlauf
- Verwendbar für Schienen und Stangen
- Für Stoffe ohne Rapport
- Für leichte oder transparente Stoffe bis mittelschwere Dekostoffe
- Bei auf- oder zugezogener Gardine immer perfekt in Form
- Ideal für kleine Fenster

- Suitable for curtain rails and rods with internal rail
- Suitable for curtain rails and rods
- For fabrics without pattern repeat
- For light and transparent fabrics up to medium-heavy curtains
- Always in perfect form no matter if curtains are opened up or closed
- Ideal for small windows

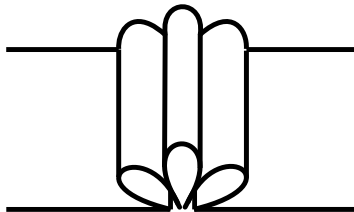



Faltenband 28 mm

Pleated Tape 28 mm

Artikel Article	Zugabe Fullness	Faltenzahl Number of pleats	Faltenabstand Distance between pleats	Rapport Repeat
6605 transparent	300 %	4	8 cm	24 cm
6606 transparent	250 %	3	8 cm	20 cm
6672 transparent	200 %	3	8 cm	16 cm
6319 transparent	150 %	1	10 cm	15 cm

- Verwendbar für Schienen und Stangen mit Innenlauf
 - Verwendbar für Schienen und Stangen
 - Für Stoffe ohne Rapport
 - Für leichte oder transparente Stoffe bis mittelschwere Dekostoffe
 - Bei auf- oder zugezogener Gardine immer perfekt in Form
 - Ideal für kleine Fenster
-
- Suitable for curtain rails and rods with internal rail
 - Suitable for curtain rails and rods
 - For fabrics without pattern repeat
 - For light and transparent fabrics up to medium-heavy curtains
 - Always in perfect form no matter if curtains are opened up or closed
 - Ideal for small windows

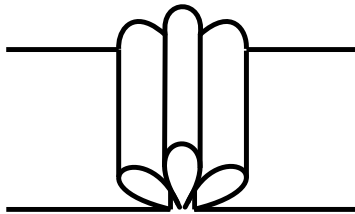



Royal Falte 150 mm

Royal Pleated Tape 150 mm

Artikel Article	Zugabe Fullness	Faltenzahl Number of pleats	Faltenabstand Distance between pleats	Rapport Repeat
6972 volltrans.	300 %	9	15 cm	45 cm
6973 volltrans.	250 %	9	16 cm	40 cm

- Verwendbar für Schienen und Stangen mit Innenlauf
- Verwendbar für Schienen und Stangen
- Nur für ganz dünne Stoffe ohne Rapport
- Bei auf- oder zugezogener Gardine immer perfekt in Form

- Suitable for curtain rails and rods with internal rail
- Suitable for curtain rails and rods
- Only for very thin fabrics without pattern repeat
- Always in perfect form no matter if curtains are opened up or closed

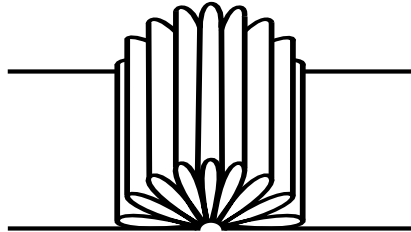



V-Faltenband 150 mm

V- Pleated Tape 150 mm

Artikel Article	Zugabe Fullness	Faltenzahl Number of pleats	Faltenabstand Distance between pleats	Rapport Repeat
6948 volltrans.	250 %	2	18 cm	45 cm
6947 volltrans.	200 %	2	18 cm	36 cm

- Verwendbar für Schienen und Stangen mit Innenlauf
- Verwendbar für Schienen und Stangen
- Band kann auch gedreht werden
- Für leichte oder transparente Stoffe bis mittelschwere Dekostoffe
- Für Stoffe ohne Rapport
- Ideal für bewegliche Dekorationen

- Suitable for curtain rails and rods with internal rail
- Suitable for curtain rails and rods
- Tape can also be turned around
- For light and transparent fabrics up to medium-heavy curtains
- For fabrics without pattern repeat

Variante 1
version 1

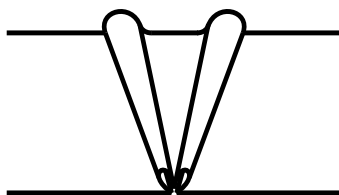

Variante 2
version 2

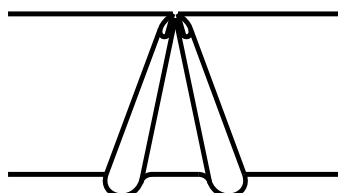



Flämische Falte 80 mm

Pinch Pleated Tape 80 mm

Artikel Article	Zugabe Fullness	Faltenzahl Number of pleats	Faltenabstand Distance between pleats	Rapport Repeat
6381 weiß/white	300 %	3	8 cm	23 cm
6385 weiß/white	250 %	3	9 cm	23 cm
6386 weiß/white	200 %	3	12 cm	24 cm

- Verwendbar für Schienen und Stangen mit Innenlauf
- Verwendbar für Schienen und Stangen
- Für leichte bis schwere Dekostoffe
- Band kann auch gedreht werden
- Für Stoffe ohne Rapport
- Ideal für bewegliche Dekorationen

- Suitable for curtain rails and rods with internal rail
- Suitable for curtain rails and rods
- For light up to heavy curtains
- Tape can also be turned around
- For fabrics without pattern repeat

Variante 1
version 1

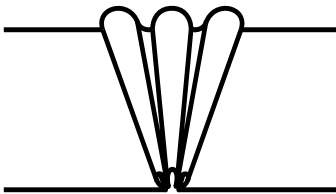

Variante 2
version 2

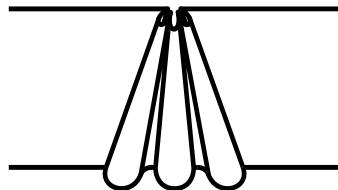



Flachfaltenband 26 mm

Flat Pleated Tape 26 mm

Artikel Article	Zugabe Fullness	Faltenzahl Number of pleats	Faltenabstand Distance between pleats	Rapport Repeat
6315 weiß/white	250%	2	8 cm	20 cm

- Verwendbar für Schienen und Stangen mit Innenlauf
 - Verwendbar für Schienen und Stangen
 - Kann nach dem Ziehen der Falten noch flach gebügelt oder genäht werden
 - Für Dekostoffe und Stores geeignet
 - Bei auf- oder zugezogener Gardine immer perfekt in Form
 - Ideal für kleine Fenster
-
- Suitable for curtain rails and rods with internal rail
 - Suitable for curtain rails and rods
 - After pulling of the pleats still can be flat ironed or sewed
 - Suitable for heavy curtains and stores
 - Always in perfect form no matter if curtains are opened up or closed
 - Ideal for small windows

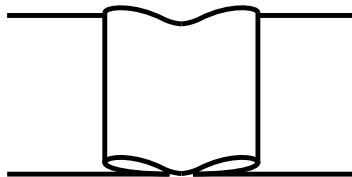



Flachfaltenband 50 mm

Flat Pleated Tape 50 mm

Artikel Article	Zugabe Fullness	Faltenzahl Number of pleats	Faltenabstand Distance between pleats	Rapport Repeat
6758 KR weiß/white	300%	2	8 cm	24 cm
6759 KR weiß/white	270%	2	8 cm	21,5 cm
6760 KR weiß/white	250%	2	8 cm	20 cm
6778 weiß/white	200%	2	10 cm	20 cm

- Verwendbar für Schienen und Stangen mit Innenlauf
- Verwendbar für Schienen und Stangen
- Kann nach dem Ziehen der Falten noch flach gebügelt oder genäht werden
- Für Dekostoffe und Stores geeignet
- Bei auf- oder zugezogener Gardine immer perfekt in Form

- Suitable for curtain rails and rods with internal rail
- Suitable for curtain rails and rods
- After pulling of the pleats still can be flat ironed or sewed
- Suitable for heavy curtains and stores
- Always in perfect form no matter if curtains are opened up or closed

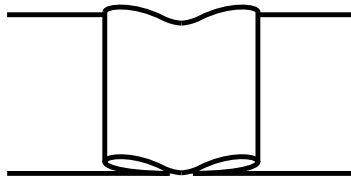



Flachfaltenband 80 mm

Flat Pleated Tape 80 mm

Artikel Article	Zugabe Fullness	Faltenzahl Number of pleats	Faltenabstand Distance between pleats	Rapport Repeat
6037 volltrans.	250 %	2	12 cm	30 cm
6038 volltrans.	300 %	2	12 cm	36 cm

- Verwendbar für Schienen und Stangen mit Innenlauf
 - Verwendbar für Schienen und Stangen (bis \varnothing 20 mm)
 - Für Stoffe ohne Rapport
 - Kann nach dem Ziehen der Falten noch flach gebügelt oder genäht werden
 - Besonders für Flächenvorhänge geeignet
 - Mit Stabeinschub für Plexiglasstab 1544
-
- Suitable for curtain rails and rods with internal rail
 - Suitable for curtain rails and rods (up to \varnothing 20 mm)
 - For fabrics without pattern repeat
 - After pulling of the pleats still can be flat ironed or sewed
 - Especially suitable for panel curtains
 - With rod pocket for panel bar rod 1544

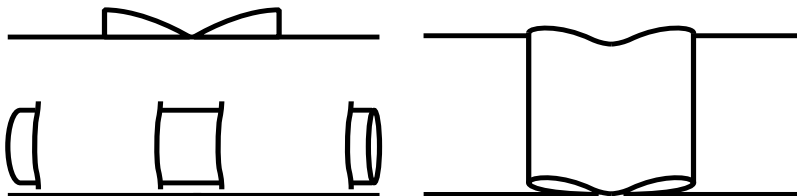



Flachfaltenband 150 mm

Flat Pleated Tape 150 mm

Artikel Article	Zugabe Fullness	Faltenzahl Number of pleats	Faltenabstand Distance between pleats	Rapport Repeat
6028 volltrans.	300 %	2	12 cm	36 cm
6029 volltrans.	250 %	2	12 cm	30 cm
6030 volltrans.	200 %	2	12 cm	24 cm

- Verwendbar für Schienen und Stangen mit Innenlauf
 - Verwendbar für Schienen und Stange
 - Kann nach dem Ziehen der Falten noch flach gebügelt oder genäht werden
 - Für Dekostoffe und Stores geeignet
 - Ideal für feststehende Dekorationen
-
- Suitable for curtain rails and rods with internal rail
 - Suitable for curtain rails and rods
 - After pulling of the pleats still can be flat ironed or sewed
 - Suitable for heavy curtains and stores
 - Ideal for fixed/static decorations

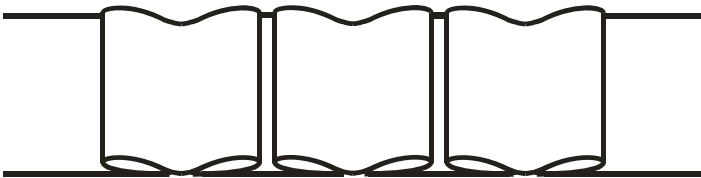



Rundfaltenband 75 mm

Round Pleated Tape 75 mm

Artikel Article	Zugabe Fullness	Faltenabstand Distance between pleats	Rapport Repeat
6835 volltrans.	250 %	10 cm	25 cm
6834 volltrans.	200 %	15 cm	30 cm

- Verwendbar für Schienen und Stangen mit Innenlauf
- Verwendbar für Schienen und Stangen
- Für Stoffe ohne Rapport
- Für leichte oder transparente Stoffe bis mittelschwere Dekostoffe
- Bei auf- oder zugezogener Gardine immer perfekt in Form

- Suitable for curtain rails and rods with internal rail
- Suitable for curtain rails and rods
- For fabrics without pattern repeat
- For light and transparent fabrics up to medium-heavy curtains
- Always in perfect form no matter if curtains are opened up or closed

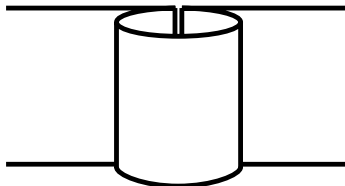



Schmuckfaltenband 150 mm

Fancy Pleated Tape 150 mm

Artikel Article	Zugabe Fullness	Faltenabstand Distance between pleats	Rapport Repeat
6952 volltrans.	250 %	10 cm	25 cm
6951 volltrans.	200 %	15 cm	30 cm

- Verwendbar für Schienen und Stangen mit Innenlauf
 - Verwendbar für Schienen und Stangen
 - Band kann auch gedreht werden
 - Für leichte oder transparente Stoffe bis mittelschwere Dekostoffe
 - Für Stoffe ohne Rapport
 - Bei auf- oder zugezogener Gardine immer perfekt in Form
-
- Suitable for curtain rails and rods with internal rail
 - Suitable for curtain rails and rods
 - Tape can also be turned around
 - For light and transparent fabrics up to medium-heavy curtains
 - For fabrics without pattern repeat
 - Always in perfect form no matter if curtains are opened up or closed

Variante 1
version 1

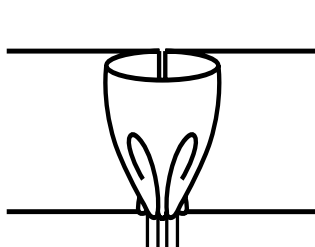

Variante 2
version 2

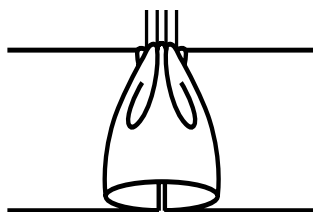



Schmuckfaltenband 80 mm

Fancy Pleated Tape 80 mm

Artikel Article	Zugabe Fullness	Rapport Repeat
6630 weiß/white	250%	7 cm

- Verwendbar für Schienen und Stangen mit Innenlauf
 - Verwendbar für Schienen und Stangen
 - Für leichte oder transparente Stoffe und leichte Dekostoffe
 - Für Stoffe mit und ohne ohne Rapport
 - Bei auf- oder zugezogener Gardine immer perfekt in Form
 - Ideal für festehende Dekorationen
-
- Suitable for curtain rails and rods with internal rail
 - Suitable for curtain rails and rods
 - For light and transparent fabrics up to light curtains
 - For fabrics with and without pattern repeat
 - Always in perfect form no matter if curtains are opened up or closed
 - Ideal for fixed/static decorations



Schmuckfaltenband 50 mm

Fancy Pleated Tape 50 mm

Artikel Article	Zugabe Fullness	Faltenabstand Distance between pleats	Rapport Repeat
6568 transparent	250 %	10 cm	26 cm
6570 transparent	300 %	8 cm	24 cm

- Verwendbar für Schienen und Stangen mit Innenlauf
- Verwendbar für Schienen und Stangen
- Für leichte oder transparente Stoffe
- Für Stoffe ohne Rapport
- Bei auf- oder zugezogener Gardine immer perfekt in Form

- Suitable for curtain rails and rods with internal rail
- Suitable for curtain rails and rods
- Tape can also be turned around
- For light and transparent fabrics
- For fabrics without pattern repeat
- Always in perfect form no matter if curtains are opened up or closed



Schmuckfaltenband 80 mm

Fancy Pleated Tape 80 mm

Artikel Article	Zugabe Fullness	Faltenabstand Distance between pleats	Rapport Repeat
6169 transparent	250 - 270 %	12 cm	32,5 cm
6170 transparent	250 - 270 %	9,1 cm	24,5 cm

- Verwendbar für Schienen und Stangen mit Innenlauf
- Verwendbar für Schienen und Stangen
- Für leichte oder transparente Stoffe bis mittelschwere Dekostoffe
- Für Stoffe ohne Rapport und mit einem Rapport von 32,5 cm
- Bei auf- oder zugezogener Gardine immer perfekt in Form

- Suitable for curtain rails and rods with internal rail
- Suitable for curtain rails and rods
- For light and transparent fabrics up to medium-heavy curtains
- For fabrics without a pattern repeat and with a pattern repeat of 32,5 cm
- Always in perfect form no matter if curtains are opened up or closed



SCHMUCK FALTENBAND



Schmuckfaltenband 80 mm

Fancy Pleated Tape 80 mm

Artikel Article	Zugabe Fullness	Faltenabstand Distance between pleats	Rapport Repeat
6169 transparent	270 %	12 cm	32,5 cm
6170 transparent	270 %	9,1 cm	24,5 cm

- Verwendbar für Schienen und Stangen mit Innenlauf
 - Verwendbar für Schienen und Stangen
 - Band kann auch gedreht werden
 - Für leichte oder transparente Stoffe bis mittelschwere Dekostoffe
 - Für Stoffe ohne Rapport und mit einem Rapport von 24,5 cm
 - Bei auf- oder zugezogener Gardine immer perfekt in Form
-
- Suitable for curtain rails and rods with internal rail
 - Suitable for curtain rails and rods
 - Tape can also be turned around
 - For light and transparent fabrics up to medium-heavy curtains
 - For fabrics without a pattern repeat and with a pattern repeat of 24,5 cm
 - Always in perfect form no matter if curtains are opened up or closed



SCHMUCK FALTENBAND



Smokband 50 mm

Smocking Tape 50 mm

Artikel Article	Zugabe Fullness	Rapport Repeat
6793 volltrans.	300%	6 cm
6794 volltrans.	250%	6 cm
6795 volltrans.	200%	6 cm

- Verwendbar für Schienen und Stangen mit Innenlauf
 - Verwendbar für Schienen und Stangen
 - Für Stoffe mit und ohne Rapport
 - Für leichte oder transparente Stoffe bis mittelschwere Dekostoffe
 - Ideal für feststehende Fensterdekorationen
-
- Suitable for curtain rails and rods with internal rail
 - Suitable for curtain rails and rods
 - For fabrics with and without pattern repeat
 - For light and transparent fabrics up to medium-heavy curtains
 - Ideal for fixed/static decorations

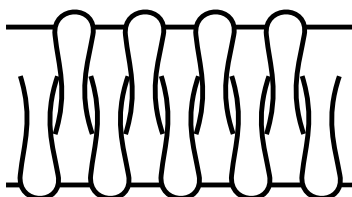



Smokband 80 mm

Smocking Tape 80 mm

Artikel Article	Zugabe Fullness	Rapport Repeat
6909 volltrans.	250 %	6,5 cm
6908 volltrans.	200 %	6,5 cm

- Verwendbar für Schienen und Stangen mit Innenlauf
 - Verwendbar für Schienen und Stangen
 - Für Stoffe mit und ohne Rapport
 - Für leichte oder transparente Stoffe bis mittelschwere Dekostoffe
 - Ideal für freistehende Dekorationen
-
- Suitable for curtain rails and rods with internal rail
 - Suitable for curtain rails and rods
 - For fabrics with and without pattern repeat
 - For light and transparent fabrics up to medium-heavy curtains
 - Ideal for fixed/static decorations

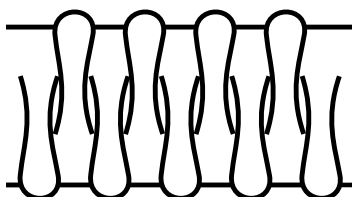



Smokband 150 mm

Smocking Tape 150 mm

Artikel Article	Zugabe Fullness	Rapport Repeat
6913 volltrans.	250 %	10 cm
6912 volltrans.	200 %	10 cm

- Verwendbar für Schienen und Stangen
 - Für leichte oder transparente Stoffe und Dekostoffe
 - Besonders geeignet für Stoffe mit Rapport
 - Ideal für freistehende Dekorationen
-
- Suitable for curtain rails and rods
 - For light or transparent fabrics and heavy curtains
 - Especially suitable for fabrics with pattern repeat
 - Ideal for fixed/static decorations

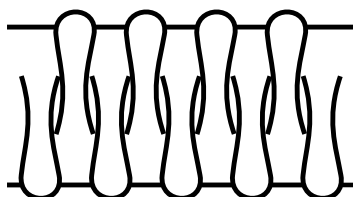



Doppelsmokband 150 mm

Double Smocking Tape 150 mm

Artikel Article	Zugabe Fullness	Rapport Repeat
6007 volltrans.	250 %	10 cm
6008 volltrans.	200 %	10 cm

- Verwendbar für Schienen und Stangen
- Für leichte oder transparente Stoffe und Dekostoffe
- Besonders geeignet für Stoffe mit Rapport
- Ideal für freistehende Dekorationen

- Suitable for curtain rails and rods
- For light or transparent fabrics and heavy curtains
- Especially suitable for fabrics with pattern repeat
- Ideal for fixed/static decorations

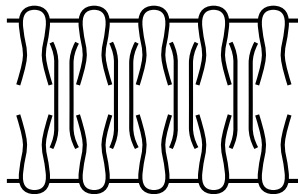



Bleistift-Smokfaltenband 150 mm

Pencil Pleated Smocking Tape 150 mm

Artikel Article	Zugabe Fullness	Faltenabstand Distance between pleats	Rapport Repeat
6981 volltrans.	300 %	3 cm	8,8 cm
6950 volltrans.	250 %	3,5 cm	8,8 cm
6949 volltrans.	200 %	3,5 cm	7 cm

- Verwendbar für Schienen und Stangen
- Band kann auch gedreht werden
- Für leichte oder transparente Stoffe und Dekostoffe
- Besonders geeignet für Stoffe mit Rapport
- Ideal für freistehende Dekorationen

- Suitable for curtain rails and rods
- Tape can also be turned around
- For light or transparent fabrics and heavy curtains
- Especially suitable for fabrics with pattern repeat
- Ideal for fixed/static decorations

Variante 1
version 1

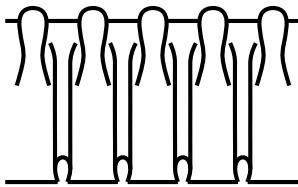

Variante 2
version 2

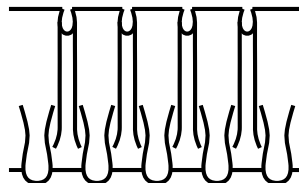



Bleistiftband 75 mm

Pencil Pleated Tape 75 mm

Artikel Article	Zugabe Fullness	Rapport Rapport
6782 volltrans.	300 %	6 cm
6783 volltrans.	250 %	6 cm
6784 volltrans.	200 %	6 cm
6015 volltrans.	150 %	6 cm

- Verwendbar für Schienen und Stangen mit Innenlauf
- Verwendbar für Schienen und Stangen
- Für Stoffe mit und ohne Rapport
- Für Dekostoffe und Stores geeignet

- Suitable for curtain rails and rods with internal rail
- Suitable for curtain rails and rods
- For fabrics with and without pattern repeat
- Suitable for heavy curtains and stores

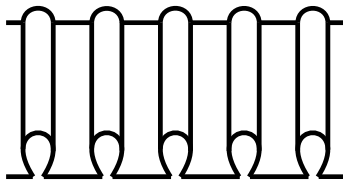



Plisseeband 50 mm

Pencil Pleated Tape 50 mm

Artikel Article	Zugabe Fullness	Rapport Repeat
6504 transparent	300 %	2,5 cm
6505 transparent	250 %	2,5 cm
6506 transparent	200 %	2,5 cm
6748 transparent	150 %	4,5 cm

- Verwendbar für Schienen und Stangen mit Innenlauf
- Verwendbar für Schienen und Stangen
- Für Stoffe mit und ohne Rapport
- Für leichte oder transparente Stoffe bis mittelschwere Dekostoffe

- Suitable for curtain rails and rods with internal rail
- Suitable for curtain rails and rods
- For fabrics with and without pattern repeat
- For light and transparent fabrics up to medium-heavy curtains

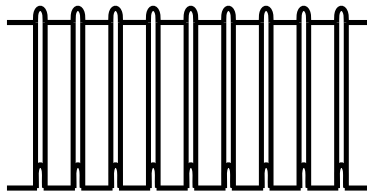



Universalband 26 mm

Universal Tape 26 mm

Artikel Article	Zugabe Fullness	Rapport Repeat
6739 weiß/white	variabel	5,5 cm

- Verwendbar für Schienen und Stangen mit Innenlauf
 - Verwendbar für Schienen und Stangen
 - Für leichte oder transparente Stoffe bis mittelschwere Dekostoffe
 - Für Stoffe mit und ohne Rapport
 - Individuelle Zugaben möglich
 - Ideal für kleine Fenster
-
- Suitable for curtain rails and rods with internal rail
 - Suitable for curtain rails and rods
 - For light and transparent fabrics up to medium-heavy curtains
 - For fabrics with and without pattern repeat
 - Individual additions possible
 - Ideal for small windows

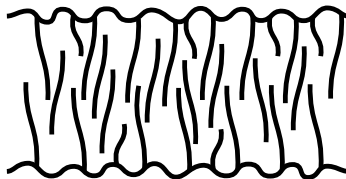



Universalband 50 mm

Universal Tape 50 mm

Artikel Article	Zugabe Fullness	Rapport Repeat
6815 volltrans.	variabel	2,5 cm

- Verwendbar für Schienen und Stangen mit Innenlauf
 - Verwendbar für Schienen und Stangen
 - Für leichte oder transparente Stoffe bis mittelschwere Dekostoffe
 - Für Stoffe mit und ohne Rapport
 - Individuelle Zugaben möglich
-
- Suitable for curtain rails and rods with internal rail
 - Suitable for curtain rails and rods
 - For light and transparent fabrics up to medium-heavy curtains
 - For fabrics with and without pattern repeat
 - Individual additions possible

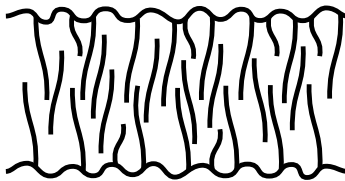



Universalband 50 mm mit 2 Taschenreihen

Universal Tape 50 mm with 2 rows of Pockets

Artikel Article	Zugabe Fullness	Rapport Repeat
6307 gebleicht	variabel	4,2 cm - 100% Baumwolle/Cotton
63070 natur	variabel	4,2 cm - 100% Baumwolle/Cotton

- Verwendbar für Schienen und Stangen mit Innenlauf
 - Verwendbar für Schienen und Stangen
 - Für leichte oder transparente Stoffe bis mittelschwere Dekostoffe
 - Für Stoffe mit und ohne Rapport
 - Individuelle Zugaben möglich
-
- Suitable for curtain rails and rods with internal rail
 - Suitable for curtain rails and rods
 - For light and transparent fabrics up to medium-heavy curtains
 - For fabrics with and without pattern repeat
 - Individual additions possible

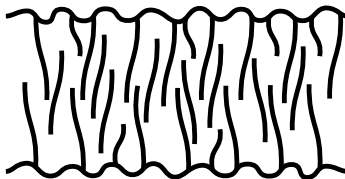



gebleicht/bleached

natur/nature

Stegband 50 mm

Slide-on-tape 50 mm

Artikel Article	Zugabe Fullness	Schlaufenabstand Distance between loops	Rapport Repeat
6879 volltrans.	variabel	10 cm	12 cm

- Mit vertikalen Stegen für Stangeneinschub (bis \varnothing 22 mm)
- Für leichte oder transparente Stoffe bis mittelschwere Dekostoffe
- Für Stoffe mit und ohne Rapport
- Individuelle Zugaben möglich
- Ideal für kleine Fenster
- Schnelle und sehr einfache Handhabung

- With vertical rack for rod insertion (up to \varnothing 22 mm)
- For light or transparent fabrics and heavy curtains
- For fabrics with and without pattern repeat
- Individual additions possible
- Ideal for small windows
- Quick and easy to handle

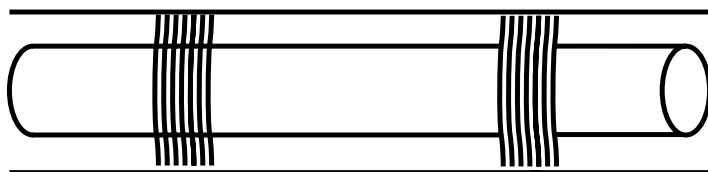

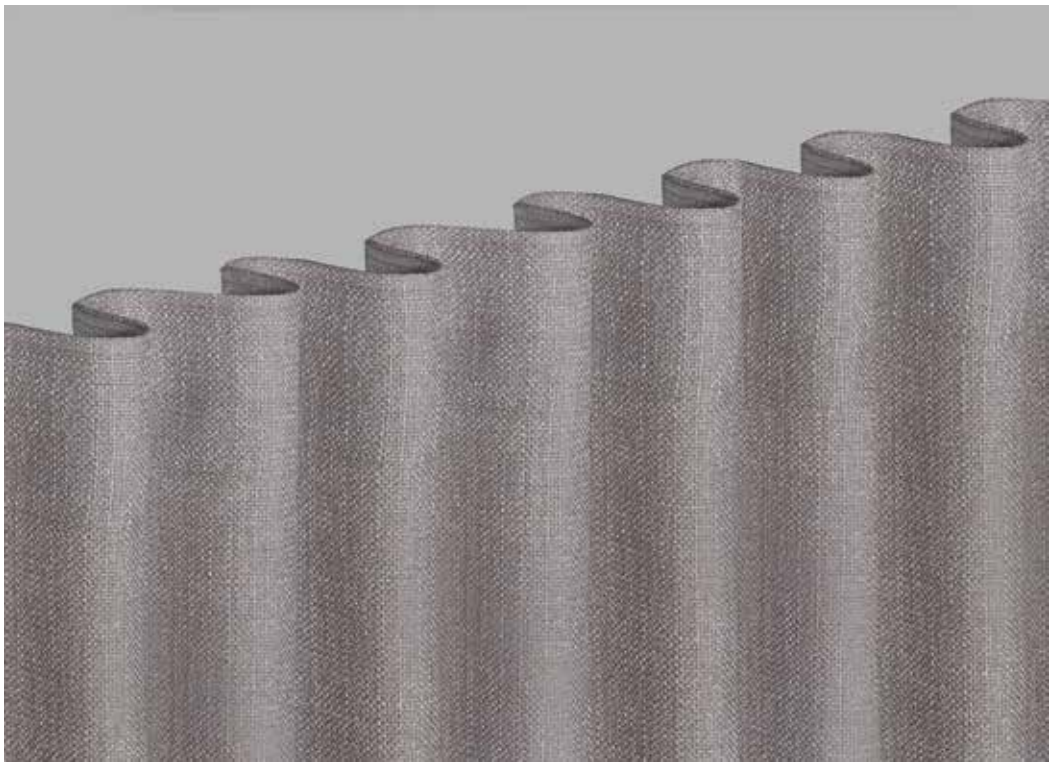

Stegband 100 mm

Slide-on-tape 100 mm

Artikel Article	Zugabe Fullness	Schlaufenabstand Distance between loops	Rapport Repeat
6874 volltrans.	variabel	17 cm	21 cm

- Mit vertikalen Stegen für Stangeneinschub (bis \varnothing 42 mm)
- Für leichte oder transparente Stoffe bis mittelschwere Dekostoffe
- Für Stoffe mit und ohne Rapport
- Individuelle Zugaben möglich
- Schnelle und sehr einfache Handhabung

- With vertical rack for rod insertion (up to \varnothing 42 mm)
- For light or transparent fabrics and heavy curtains
- For fabrics with and without pattern repeat
- Individual additions possible
- Quick and easy to handle

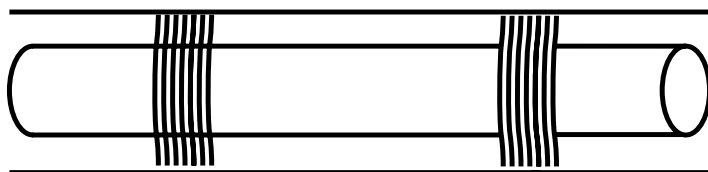

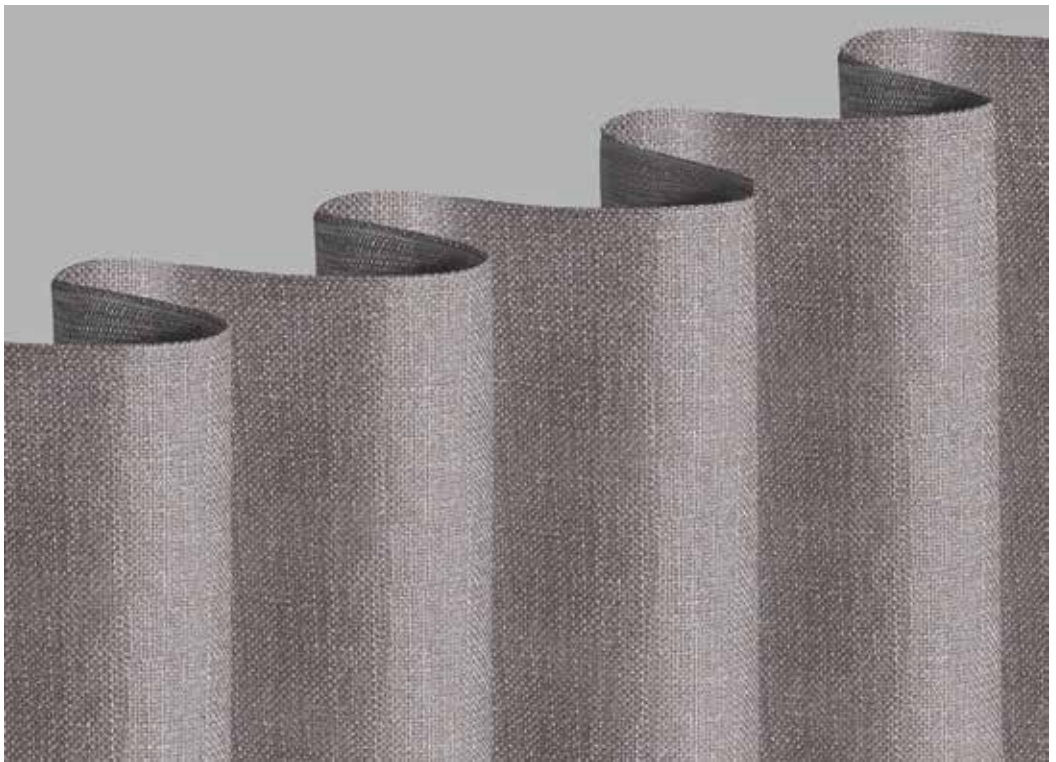

Stegband mit Smokfalte 50 mm

Smocking Slide-on-tape 50 mm

Artikel Article	Zugabe Fullness	Rapport Repeat
6905 volltrans.	250 %	18 cm
6904 volltrans.	200 %	12 cm

- Mit vertikalen Stegen für Stangeneinschub (bis \varnothing 22 mm)
- Für leichte oder transparente Stoffe bis mittelschwere Dekostoffe
- Für Stoffe mit und ohne Rapport
- Ideal für feststehende Fensterdekorationen

- With vertical rack for rod insertion (up to \varnothing 22 mm)
- For light or transparent fabrics and heavy curtains
- For fabrics with and without pattern repeat
- Ideal for fixed/static decorations

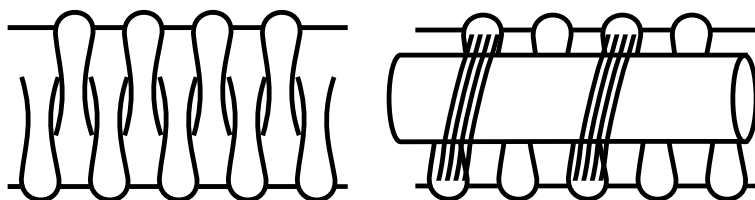



Stegband mit Smokfalte 100 mm

Smocking Slide-on-tape 100 mm

Artikel Article	Zugabe Fullness	Rapport Repeat
6907 volltrans.	250 %	14 cm
6906 volltrans.	200 %	14,3 cm

- Mit vertikalen Stegen für Stangeneinschub (bis \varnothing 42 mm)
- Für leichte oder transparente Stoffe bis mittelschwere Dekostoffe
- Für Stoffe mit und ohne Rapport
- Ideal für feststehende Fensterdekorationen

- With vertical rack for rod insertion (up to \varnothing 42 mm)
- For light or transparent fabrics and heavy curtains
- For fabrics with and without pattern repeat
- Ideal for fixed/static decorations

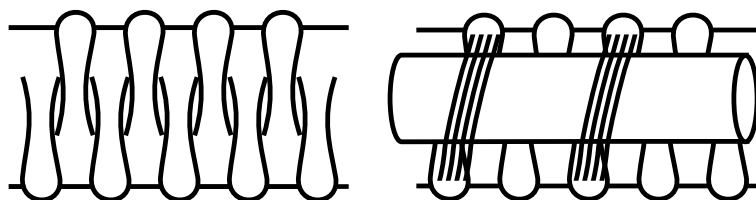

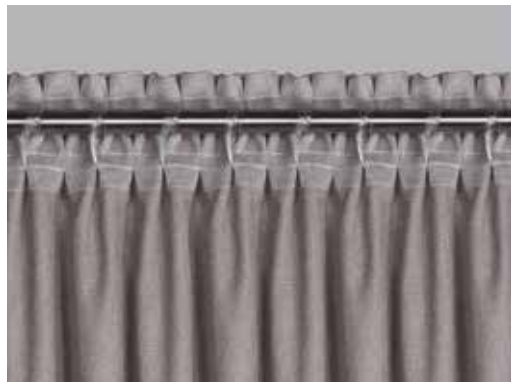

Ösenband 100 mm

Eyelet Tape 100 mm

Artikel Article		Faltenabstand Distance between pleats	Rapport Repeat
60410	8 Farben / colours	variabel	17,5 cm
60780	7 Farben / colours	variabel	10 cm

- Geeignet für Stangen bis 36 mm Durchmesser
- Für leichte oder transparente Stoffe bis mittelschwere Dekostoffe
- Für Stoffe mit und ohne Rapport
- Ideal für bewegliche Dekorationen
- Individuelle Zugaben möglich
- Schnelle und sehr einfache Handhabung

- Suitable for curtain rods with a maximum diameter of 36 mm
- For light or transparent fabrics and heavy curtains
- For fabrics with and without pattern repeat
- Ideal for mobile decorations
- Individual additions possible
- Quick and easy to handle



col. 0001 weiß



col. 0002 offwhite



col. 0411 beige



col. 0200 braun



col. 0040 schlamm



col. 1140 grau



col. 0810 anthrazit



col. 0999 schwarz



ÖSEN BAND

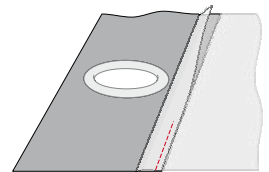

Bistro Ösenband 60 mm

Eyelet Tape for Cafe-Style Curtains 60 mm

Artikel Article		Faltenabstand Distance between pleats	Rapport Repeat
60410	8 Farben / colours	variabel	17,5 cm
60780	7 Farben / colours	variabel	10 cm

- Geeignet nur für Stangen bis 20 mm Durchmesser
 - Für leichte oder transparente Stoffe bis mittelschwere Dekostoffe
 - Für Stoffe mit und ohne Rapport
 - Ideal für kleine Fenster
 - Ideal für bewegliche Dekorationen
 - Individuelle Zugaben möglich
 - Schnelle und sehr einfache Handhabung
-
- Suitable for curtain rods with a maximum diameter of 20 mm
 - For light or transparent fabrics and heavy curtains
 - For fabrics with and without pattern repeat
 - Ideal for small windows
 - Ideal for mobile decorations
 - Individual additions possible
 - Quick and easy to handle



col. 0001 weiß



col. 0002 offwhite



col. 0411 beige



col. 0200 braun



col. 0040 schlamm



col. 1140 grau



col. 0810 anthrazit



ÖSEN BAND

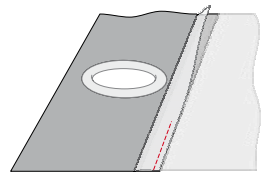

Zubehör

Accessoires



1. Gardinenhaken

Hook

Art. 14054

für (for)

Art. 6113, 6122, 61130,

Art. 6112, 6121, 61120,

Art. 6135, 6136,

Art. 6211

Art. 6308, 6309



Endhaken

End-hook

Art. 14060

für (for)

Art. 6113, 6122, 61130,

Art. 6112, 6121, 61120,

Art. 6135, 6136,

Art. 6211

Art. 6308, 6309



Bremse

stopper for Newave

Art. 14143

für (for)

Art. 6113, 6122, 61130,

Art. 6112, 6121, 61120,

Art. 6135, 6136,

Art. 6211

Art. 6308, 6309



1. Gardinenhaken

Hook

Art. 14166

für (for)

Art. 61130, 61120



Endhaken

End-hook

Art. 14167

für (for)

Art. 61130, 61120



Bremse

stopper for Newave

Art. 14168

für (for)

Art. 61130, 61120

Zubehör

Accessoires

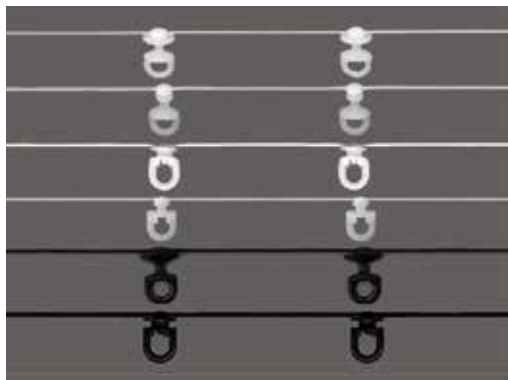

Kordeln

Glider cords

Art. 14051 6 cm

Art. 14067 6 cm

Art. 14082 6 cm

Art. 14139 6 cm

Art. 14133 6 cm

Art. 14169 6 cm



1. Gardinenhaken

Hook

Art. 14155

für (for)

Art. 6113, 6122, 61130,

Art. 6112, 6121, 61120,

Art. 6135, 6136,

Art. 6211

Art. 6308, 6309

und für viele Artikel mehr

and for many more other articles



Drehgleiter mit Faltenlegehaken

Trick slider

Art. 1700

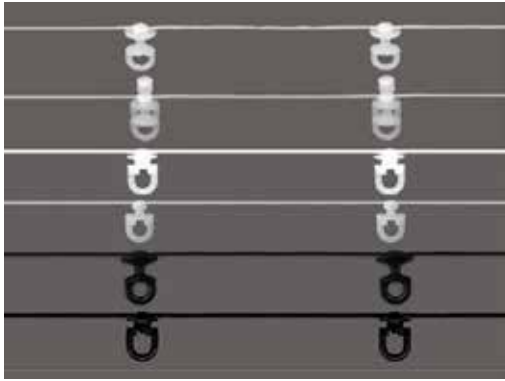

Kordeln

Glider cords

- Art. 14052 8 cm
- Art. 14072 8 cm
- Art. 14109 8 cm
- Art. 14140 8 cm
- Art. 14134 8 cm
- Art. 14170 8 cm



1. Gardinenhaken

Hook

Art. 14189

für (for)
Art. 61130, 61120



1. S-Ring

S-ring

Art. 1853

2. Faltenhaken

Pleat hook

Art. 6273

3. Schnurhalter

Cord holder

Art. 1854

Zubehör

Accessoires



Kunststoff Clipse
Plastic clips
Art. 14116



Glasfaserstab
Glasfibre bar Art. 14115



Verbinder für Glasfaserstab
Connector for Glasfibre bar
Art. 14128

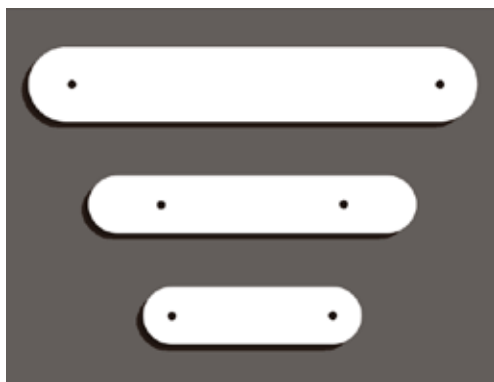

Bleistäbe

Lead weights

Art. 14 013	13g
Art. 26 025	25g
Art. 51 050	50g

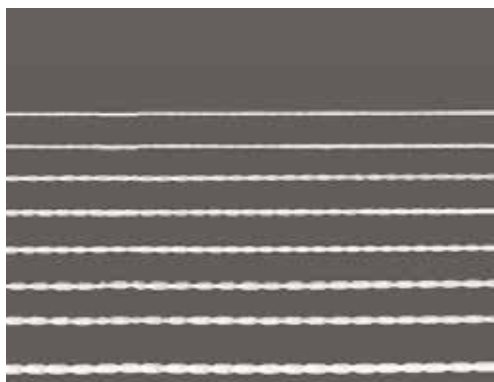

Bleiband-Walzen

Lead tape cylinders

Art. 14 014	14g
Art. 25 025	25g
Art. 35 035	35g
Art. 50 050	50g
Art. 70 070	70g
Art. 85 085	85g
Art. 100 100	100g
Art. 150 150	150g

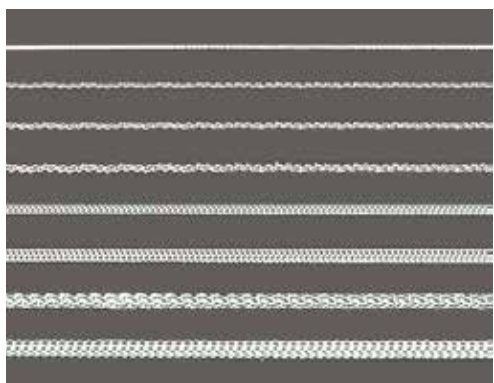

Raffrolloschnüre

Blind Cords

Art. 3285	1 mm
Art. 3272	1,5 mm
Art. 3262	1,2 mm
Art. 3808	2 mm
Art. 3277	2 mm
Art. 3255	2,5 mm
Art. 3287	3 mm
Art. 3269	5 mm





Gustav Gerster GmbH & Co. KG

Memminger Strasse 18
88400 Biberach/Riss
GERMANY

Verkauf Inland

Tel.: 07351 586-500
Fax.: 07351 586-5400

verkauf@gerster.com
www.gerster.com

Export

Tel.: +49 7351 586-501
Fax.: +49 7351 586-5408

export@gerster.com
www.gerster.com



QUALITY