

The new  
curtain tape  
generation

# NEUAVE



Newave wave pleat  
tape with supplies

Sewing instructions for fabrics  
with and without pattern repeat

Gerster  
CURTAIN TAPES

Clever  
decoration ideas

Calculator for  
needed fabric amount





sheer: **Art. 11132** col. 0001, curtain tape: **Art. 6112** 200%

## All benefits at a glance

### Easy to use and time saving

The new generation curtain tape in Gerster's Collection "Newave" is easy to use and therefore saves a lot of time and cost.

### Decorating with a certain pattern repeat

You can decorate wave pleats according to the pattern repeat of the fabric

### Six quick variations

The curtain tapes with 8 cm and 6 cm spacing between the pleats with curtain fullness of either 2, 2.5 or 2.8 allow you to select one of 6 varieties for your new curtain decoration.

Should you wish to have your own individual curtain fullness, any of the other loops can be used to insert the curtain hooks in accordance with your preference.

### Easy insertion without counting

The curtain tapes are manufactured with three different visible and tangible markings. These directly indicate where the required hooks (e.g. art. 14054, 14166, 14155, 14189) need to be placed without having to count each individual pocket.

### Easy hanging and removal of the curtains

The Newave curtain tape allows easy hanging and attachment as well as the removal of curtains for laundering. Simply insert the hooks, one by one, into the gliders.

### Swivel patented gliders

The swivel gliders of the cord easily adjust to the gathers in the curtain, always letting your curtain hang with a nice wave.



### Stopper

No. 14143 and no. 14168 are a brakes which is placed onto the last glider in the inside track. The curtain can thus be perfectly fixated at any point in the the track.

### One fabric – two designs

Fabrics with pattern repeat allow special and clever decoration possibilities due to the effect given when opening and closing the curtain.

### Suitable for curtain rails + rods with inside track systems

Suitable for curtain rods and rails with inside track systems. The cord gliders (no. 14051....) can be used on most of the **commercially** available rail and rod systems with an inside track. (minimum depth of 6 cm). Also the black gliders on both cords nos. 14133 (6 cm) and 14134 (8 cm) can be used on most of the **commercially** available rod and rail systems with a minimum depth of 6 mm and are especially suitable for heavy in-betweens or deco fabrics. The carrier cord gliders for nos. 14067 and 14072 are especially suited to **narrow** inner tracks. For **very shallow** inside tracks we suggest use of the cord gliders nos. 14082 (6 cm) and 14109 (8 cm). For **very small** inner track systems we suggest using no. 14139 (6 cm and 14140 (8 cm).

### End hooks for a perfect wave finish

The end hook (No. 14060) has two hook attachments and can be used on any rail.



### Delivery pre-assembled directly from stock

The pre-assembled cords with the curtain gliders are available directly from stock!

### Calculator for fabric amount as app

With this app for use on any smartphone you can calculate the amount of fabric, fullness and number of gliders needed for fabrics with or without repeat.



### Training video and instructions for use

You will find our video in the Mediathek on our homepage [www.gerster.com](http://www.gerster.com) and also on YouTube with **Newave curtain tape** as search.



## Inhalt

All benefits at a glance	03
Tool for calculating the fabric	05
Curtain tape Accessoires	05
NEUAVE 6113 und 6122 6 cm distance between gliders	06
NEUAVE black edition 61130 6 cm distance between gliders	08
NEUAVE 6112 und 6121 8 cm distance between gliders	10
NEUAVE black edition 61120 8 cm distance between gliders	12
Table for calculating the fabric amount <b>without</b> pattern repeat	15
Sewing instructions for fabrics <b>without</b> a pattern repeat	15
Table for calculating the fabric amount <b>with</b> pattern repeat	19
Sewing instructions for fabrics <b>with</b> a pattern repeat	19
One fabric – two designs <b>Open - Close Effect</b>	27



sheer: **Art. 11416** col. 0020, curtain tape: **Art. 6122** ca. 220%,  
fabric: **Art. 7657** col. 0084, curtaintape: **Art. 6122** 250%

# Tool for calculating the fabric amount

Please follow the below mentioned link:  
<http://gerster.com/stoffmengkalkulator/>

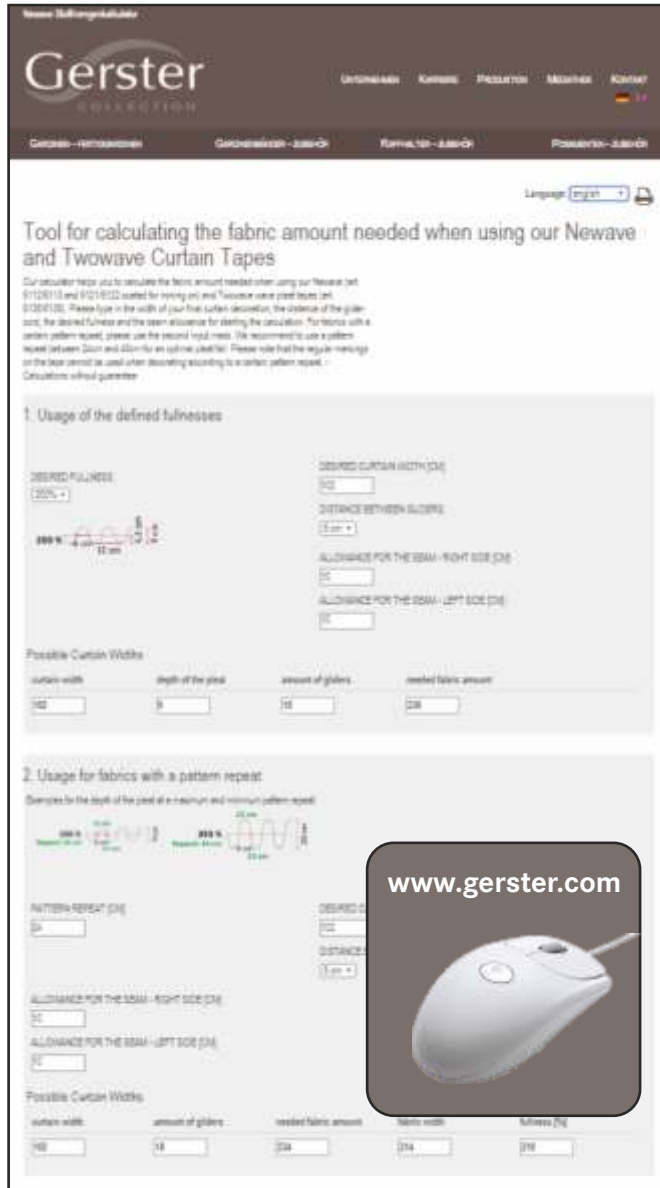

# Now available as an app

Available for **iOS** in the App Store and for **Android** in the Google Play Store!



Our Newave calculator is now also available as an app. You can use it to calculate the amount of the needed fabric and gliders.

For fabrics without a pattern repeat please use the first input mask. The regular markings on the tape can be used in this case.

## Calculating tool for fabrics **without** pattern repeat

Please enter the following:

- 1) Desired fullness
- 2) Desired curtain width
- 3) Distance between the gliders
- 4) Allowance for the seam on the left and right side

**Results:** possible curtain widths, amount of gliders, depth of the pleats, needed fabric amount. For fabrics with a certain pattern repeat, please use the second input mask. We recommend to use a pattern repeat between 24cm and 46cm for a perfect fall of the pleats.

## Calculating tool for fabrics **with** pattern repeat.

Please enter the following:

- 1) Pattern repeat
- 2) Desired curtain width
- 3) Distance between gliders
- 4) Allowance for the seam on the left and right side

**Results:** curtain width, fabric width, amount of gliders, fullness, needed fabric amount.



1.



2.



3.

# NEUAVE - Tape Accessoires



**NEUAVE App for all mobile devices!**



NEUAVE

# NEUAVE tape for small pleats

art. 6113 and art. 6122

coated is coated for ironing and easier handling

distance between gliders: **6 cm**

depth of the pleat: 9 to 14 cm

curtain tape:

Art. 6113/6122 →

End-hook: Art. 14060



Breake:

Art. 14143

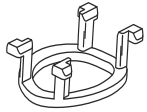

Hook:

Art. 14054 and Art. 14155

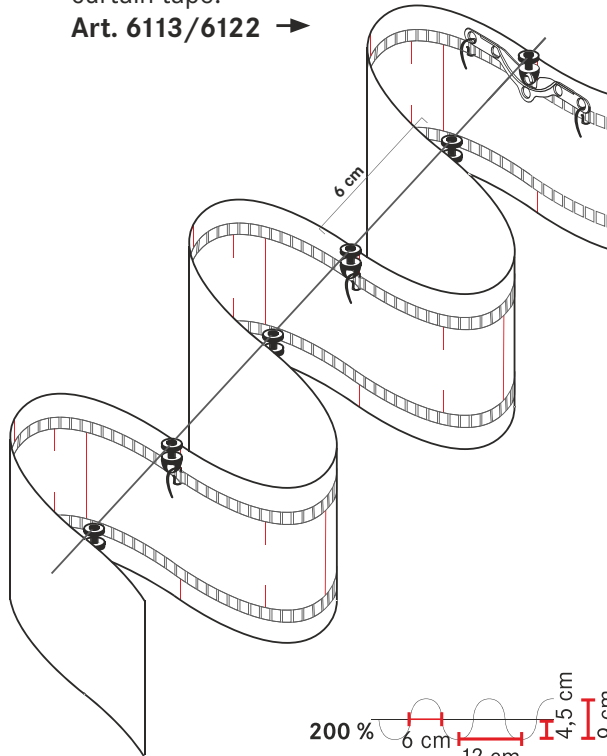
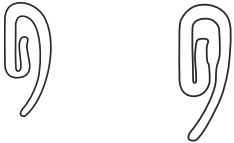

pattern repeat:

at a **200 %** fullness: 12 cm

at a **250 %** fullness: 15 cm

at a **280 %** fullness: 17 cm

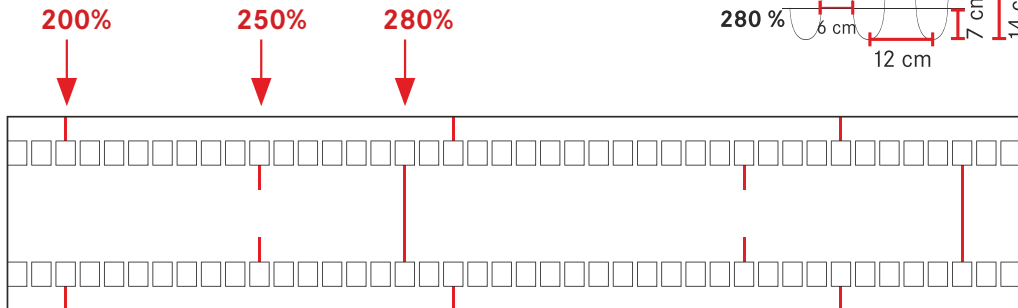
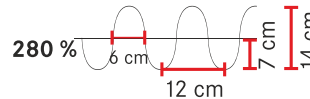
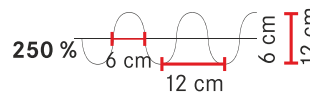
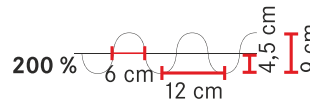

**6 cm cords**

distance between gliders: **6 cm**

**rails and rods**

Cross section picture

for **standard** rails and rods with inside track system:

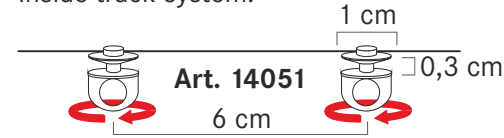

Art. 14051



for **standard** rails and rods with inside track system:

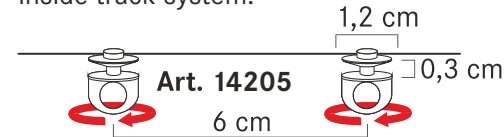

Art. 14205



for **narrow** inside track systems:

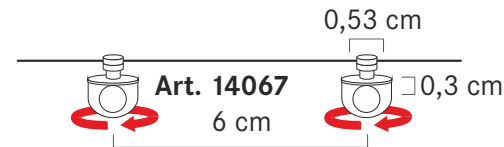

Art. 14067



for **flat** inside track systems:



Art. 14082



for **very small** inner track systems:

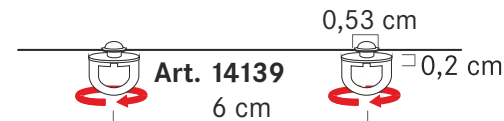

Art. 14139



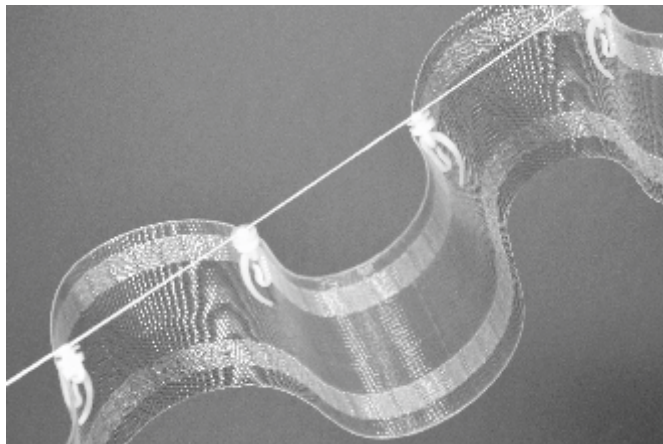
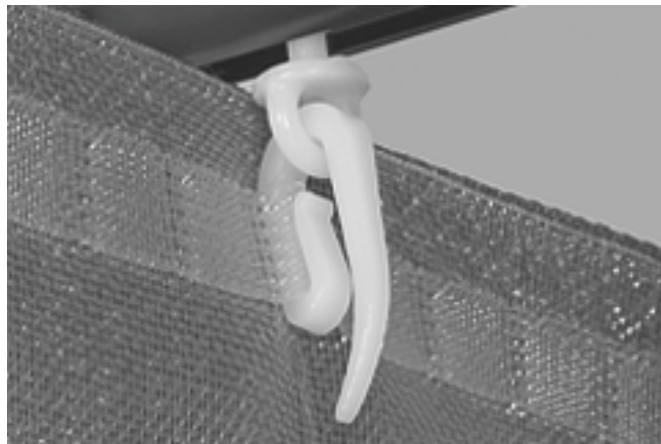

# NEUAVE black edition for small pleats

Art. 61130 in col. black

distance between gliders: **6 cm**  
depth of the pleat: 9 to 14 cm

End-hook: Art. 14167



Breake: Art. 14168



Hook: Art. 14166 und Art. 14189



pattern repeat:

at a **200 %** fullness: 12 cm  
at a **250 %** fullness: 15 cm  
at a **280 %** fullness: 17 cm

**200%**      **250%**      **280%**

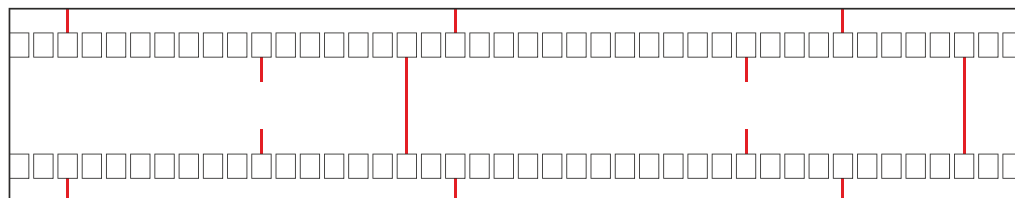

curtain tape:  
Art. 61130

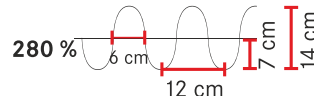
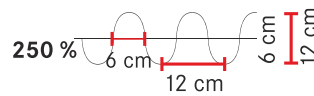
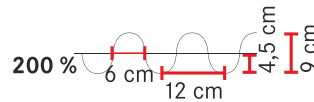
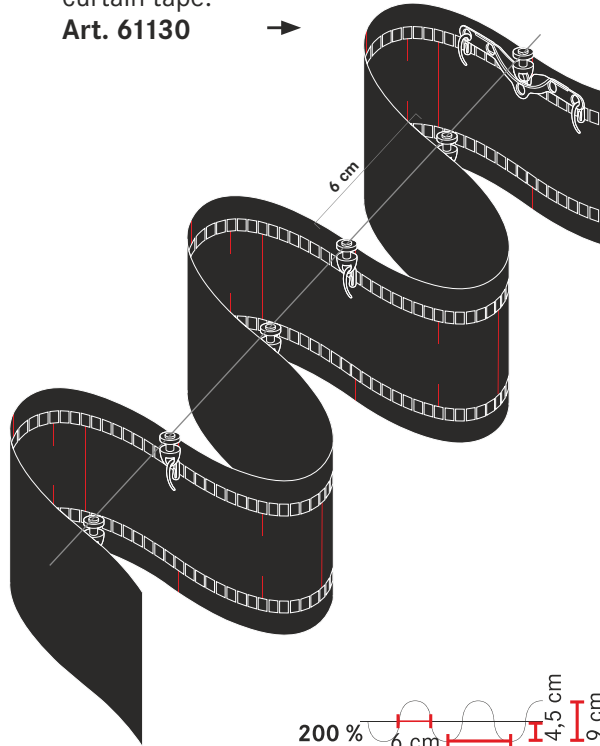

**6 cm cords**

distance between gliders: **6 cm**

**rails and rods**

Cross section picture

for **standard** rails and rods with inside track system in **col. black**:

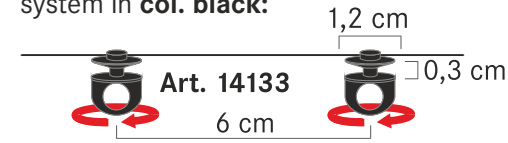

Art. 14133

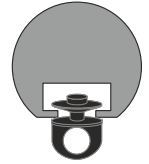
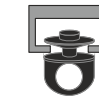

for **flat** inside track systems in **col. black**:

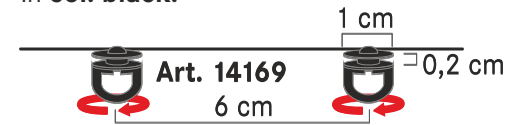

Art. 14169



for **mini** inside track systems in **col. black**:

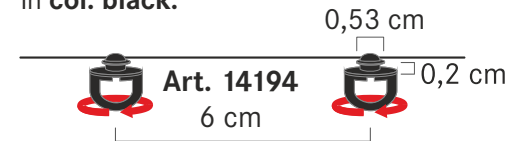

Art. 14194



for **standard** rails and rods with inside track system in **col. black**:



Art. 14186



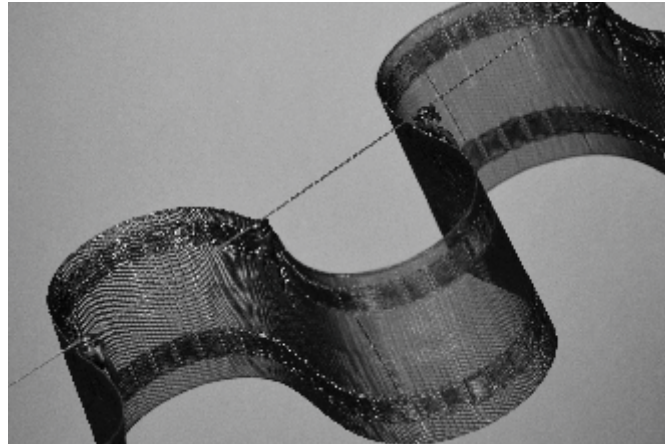
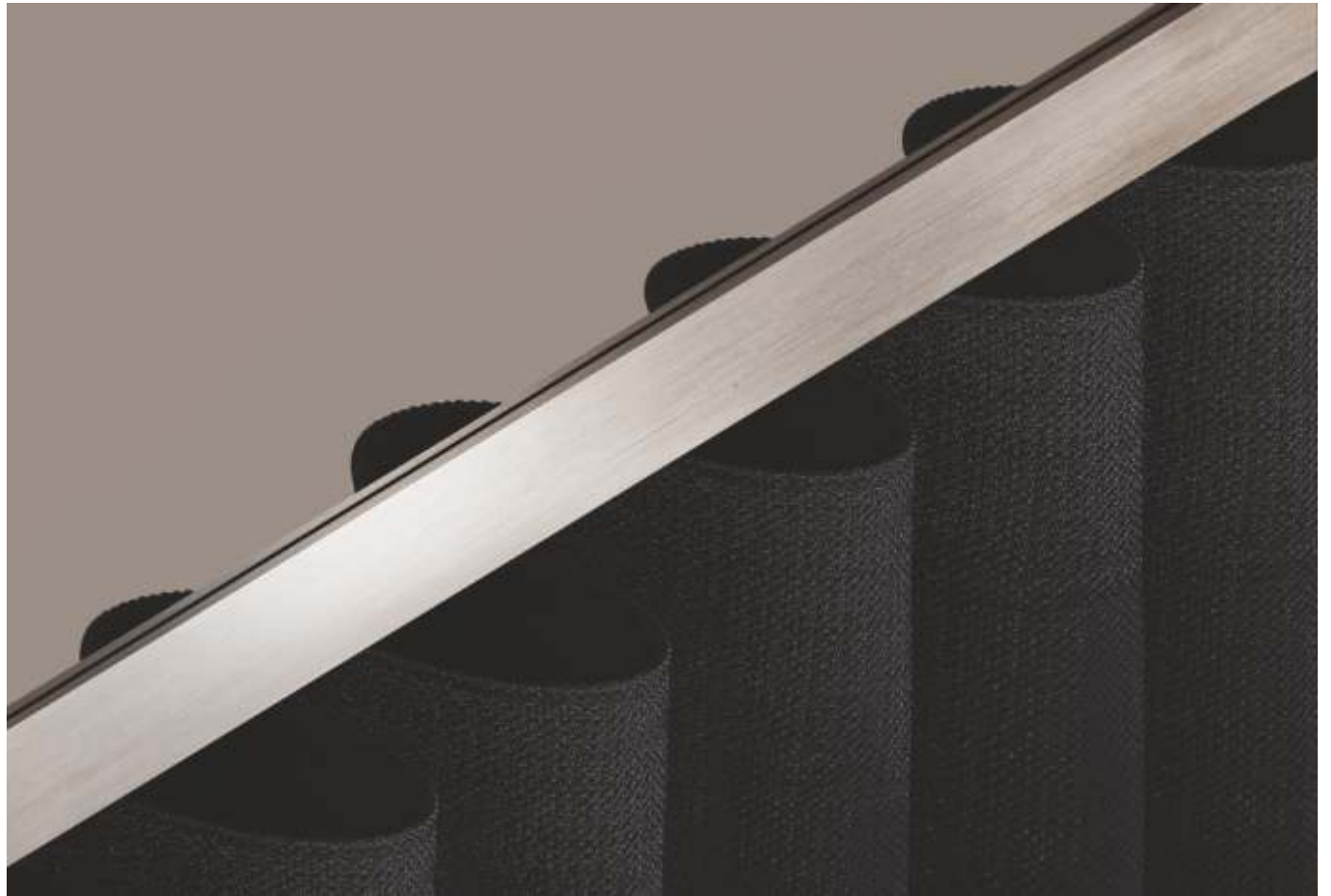

# NEUAVE tape for large pleats

art. 6112 and art. 6121

coated is coated for ironing and easier handling

distance between gliders: **8 cm**

depth of the pleat: 12 to 18 cm

End-hook: **Art. 14060**



Breake:

**Art. 14143**

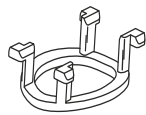

hook:

**Art. 14054 and Art. 14155**

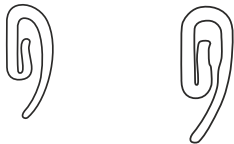

**pattern repeat:**

at a **200 %** fullness: 16 cm

at a **250 %** fullness: 20 cm

at a **280 %** fullness: 23 cm

**200%**      **250%**      **280%**

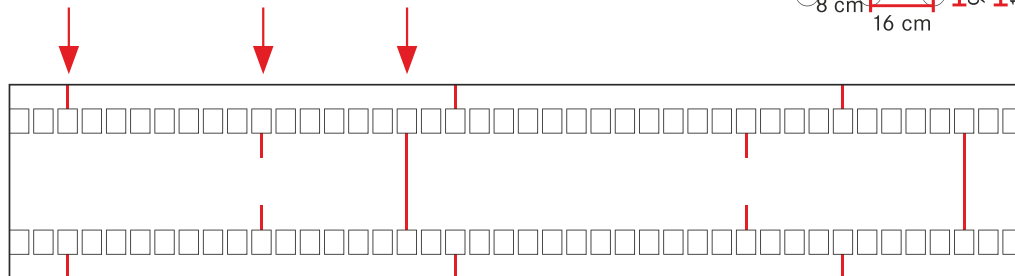

curtain tape:

**Art. 6112/6121** →

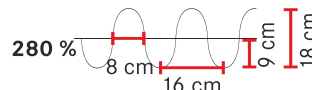
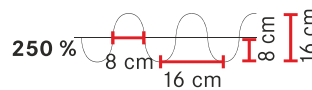
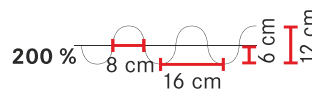
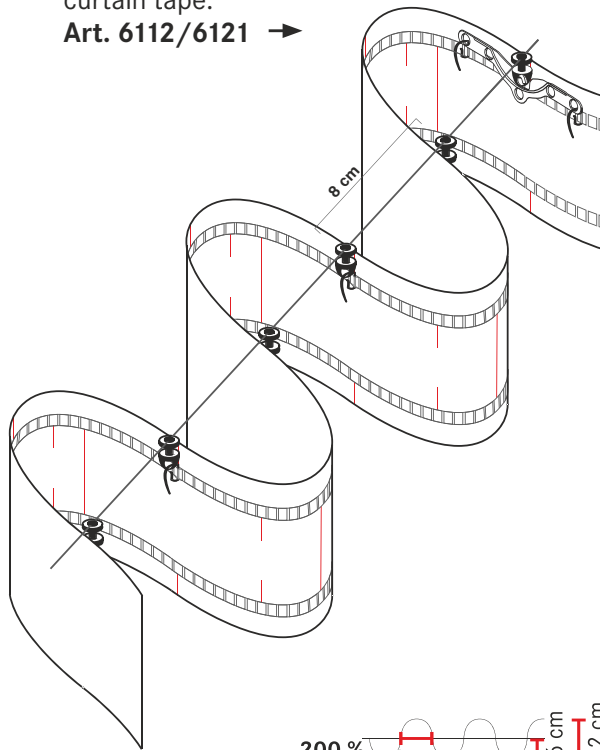

**8 cm cords**

distance between gliders: **8 cm**

**rails and rods**

Cross section picture

for **standard** rails and rods with inside track system:

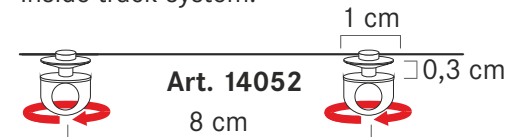

**Art. 14052**

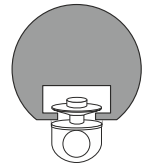
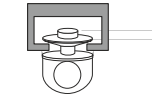

for **standard** rails and rods with inside track system:

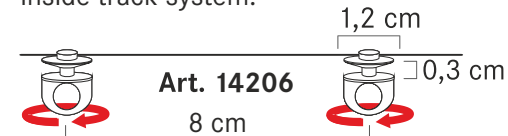

**Art. 14206**



for **narrow** inside track systems:

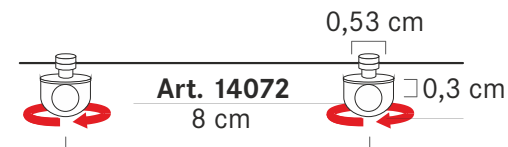

**Art. 14072**



for **flat** inside track systems:

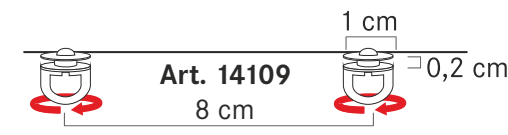

**Art. 14109**



for **very small** inner track systems:



**Art. 14140**



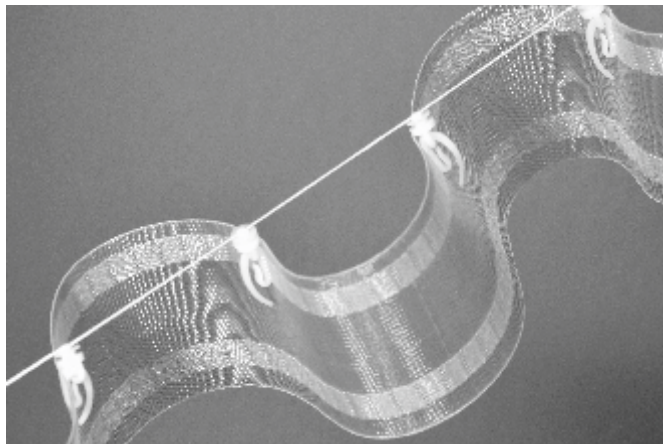
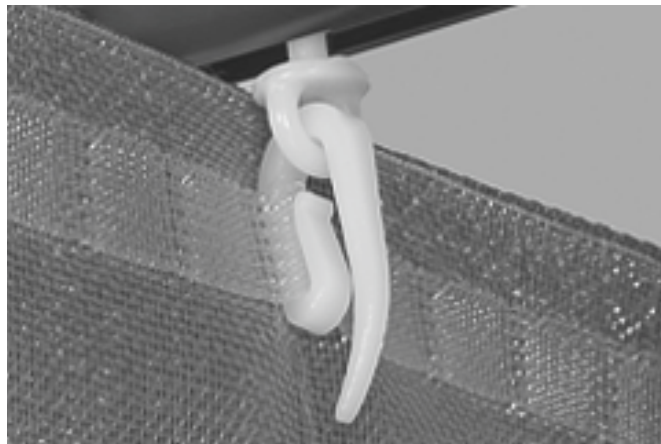

# NEUAVE black edition for large pleats

Art. 61120 in col. black

distance between gliders: **8 cm**  
depth of the pleat: 12 to 18 cm

curtain tapes:  
Art. 61120

End-hook: Art. 14167



Breake: Art. 14168



Hook:  
Art. 14166 and Art. 14189

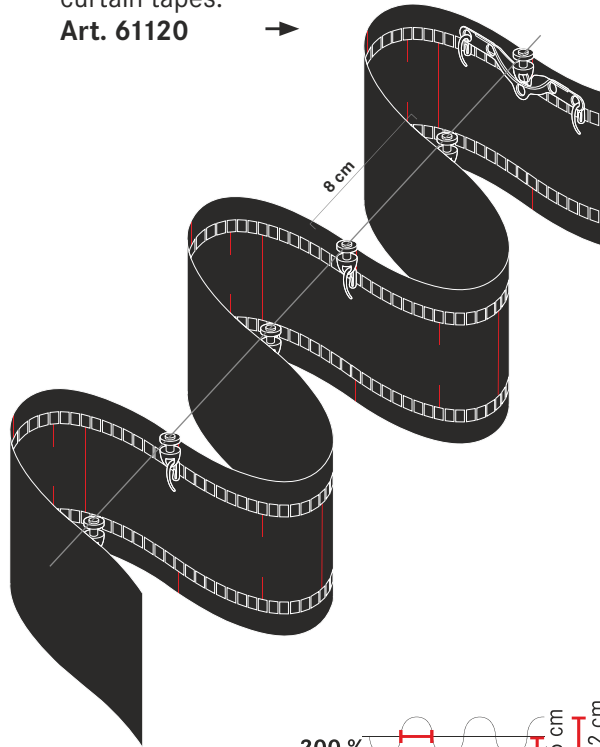

pattern repeat:

at a **200 %** fullness: 16 cm  
at a **250 %** fullness: 20 cm  
at a **280 %** fullness: 23 cm

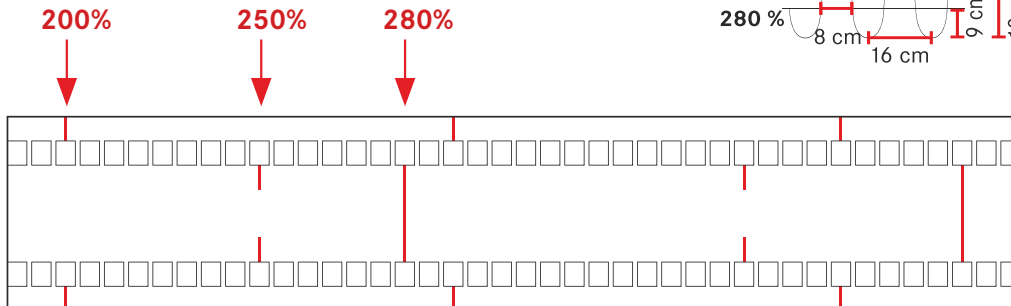
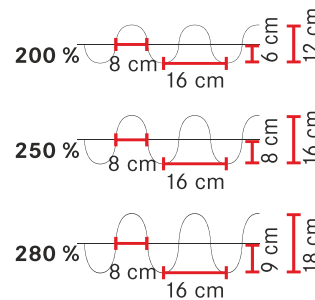

**8 cm cords**  
distance between gliders: **8 cm**

**rails and rods**  
Cross section picture

for **standard** rails and rods with inside track system in **col. black**:

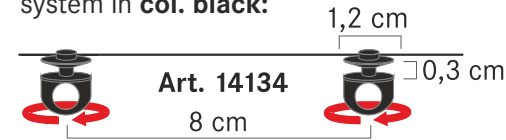

Art. 14134

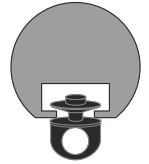

for **flat** inside track systems in **col. black**:

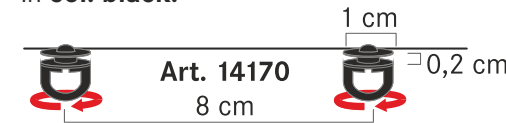

Art. 14170



for **mini** inside track systems in **col. black**:

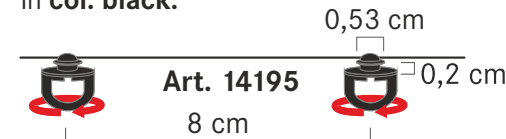

Art. 14195



for **standard** rails and rods with inside track system in **col. black**:

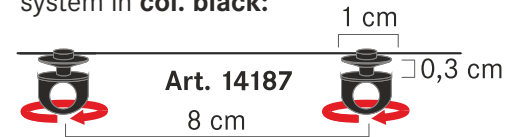

Art. 14187



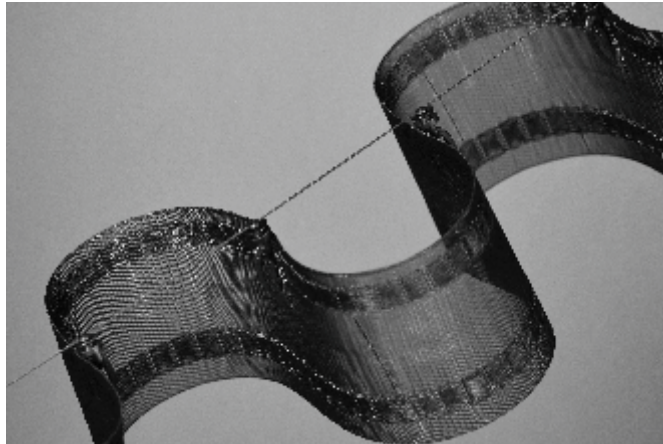



sheer: **art. 11427** col. 0010, curtain tape: **art. 6112** 250%

## Table for calculating the fabric amount without pattern repeat

art. 6113 uncoated

art. 6122 coated for ironing and easier handling

art. 61130 in col. black

matching glider cords:

art. 14051, 14205, 14067, 14082, 14139, 14186, 14133, 14169 and 14194

distance between 6 cm

Table for calculating the fabric amount without pattern repeat. Table for art. 6113, art. 6122 and art. 61130, distance between 6 cm carrier cord art. 14051, 14205, 14067, 14082, 14139, 14186, 14133, 14169 and 14194				
possible curtain width in cm	amount of gliders	needed fabric amount:		
		200% 1 : 2,0	250% 1 : 2,5	280% 1 : 2,8
42	8	96	120	136
54	10	120	150	170
66	12	144	180	204
78	14	168	210	238
90	16	192	240	272
102	18	216	270	306
114	20	240	300	340
126	22	264	330	374
138	24	288	360	408
150	26	312	390	442
162	28	336	420	476
174	30	360	450	510
186	32	384	480	544
198	34	408	510	578
210	36	432	540	612
222	38	456	570	646
234	40	480	600	680
246	42	504	630	714
258	44	520	660	748
270	46	552	690	782
282	48	576	720	816
294	50	600	750	850

art. 6112 uncoated

art. 6121 coated for ironing and easier handling

art. 61120 in col. black

matching glider cords:

art. 14052, 14206, 14072, 14109, 14140, 14187, 14134, 14170 and 14195

distance between 8 cm

Please add the hem on both sides to the fabric amounts given in the grids for fabrics **without** pattern repeat!

Table for calculating the fabric amount without pattern repeat. Table for art. 6112, art. 6121 and art. 61120 distance between 8 cm carrier cord art. 14052, 14206, 14072, 14109, 14140, 14187, 14134, 14170 and 14195				
possible curtain width in cm	amount of gliders	needed fabric amount:		
		200% 1 : 2,0	250% 1 : 2,5	280% 1 : 2,8
40	6	96	120	138
56	8	128	160	184
72	10	160	200	230
88	12	192	240	276
104	14	224	280	322
120	16	256	320	368
136	18	288	360	414
152	20	320	400	460
168	22	352	440	506
184	24	384	480	552
200	26	416	520	598
216	28	448	560	644
232	30	480	600	690
248	32	512	640	736
264	34	544	680	782
280	36	576	720	828
296	38	608	760	874

## I. Sewing instructions for fabrics **without** a pattern repeat

(single-coloured and horizontal patterns)

**Please take note for coated wave tapes**

When considering to use the coated wave tapes, please take note that art. 6121 and 6122 have an adhesive crystalline coating and were manufactured especially for working with light and transparent fabrics.

You fixate the tapes exactly and evenly with an iron. After that, sewing is no longer a problem. Curtain types such as voile or organza can be brought into a perfect wave form.



Please remember that with coated tapes the fabric must be slightly turned over the top edge.

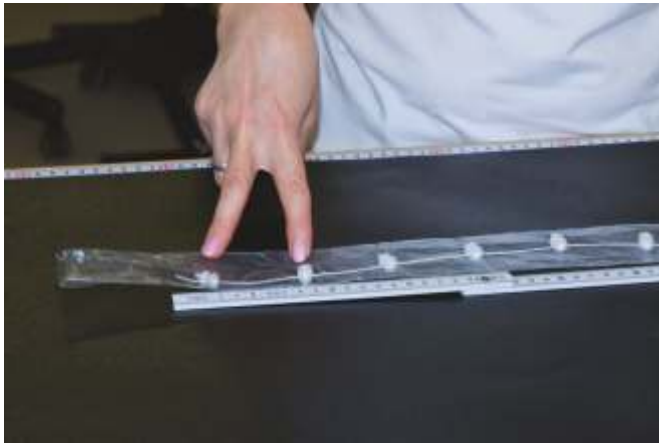

**01** Lay the carrier cord along the desired width of your window decoration. Count the gliders of the cord to ensure you get an even number so that the curtain will hang in a continuous wave.



**200%**      **250%**      **280%**

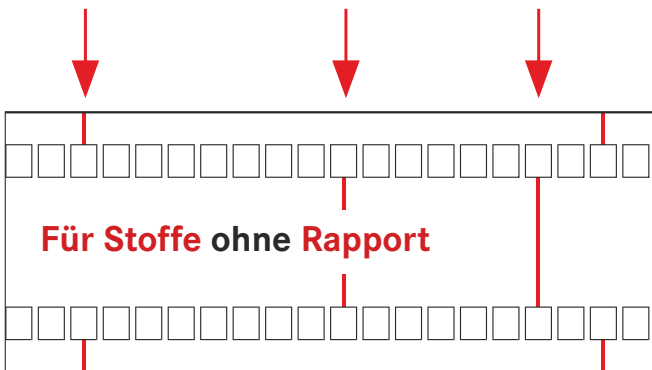

**02** For fabrics without pattern repeat: Count the same number of markings that correspond to the desired curtain fullness (2, 2.5 or 2.8). Add a ½ of the pleat depth on each side to obtain a continuous curtain wave, add 2cm on each side and cut the tape. Cut the curtain fabric to the same width as the curtain tape. Do not forget to add an allowance for the seam.



**03** Sew the hem on both sides.



**04** Make a 2cm fold from the top and iron the upper fabric edge. Then fold the curtain tape on both sides (2cm) and lay it on the upper edge of the curtain.



**07** Simply insert the hooks into the loops that correspond to the desired curtain fullness

Insert the end hook in the last glider of the carrier cord and fix it with two hooks.

**05** Iron on the coated curtain tape without any header.

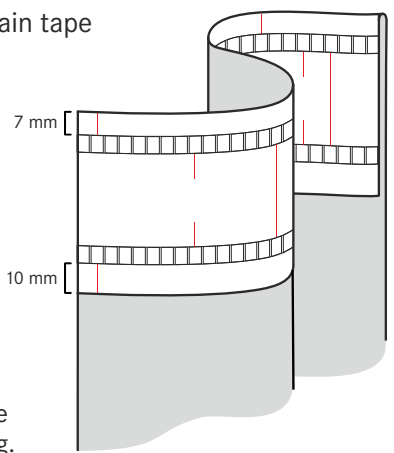

Important: Tape should be sewn on without overhang.



**08** Thread the fully assembled carrier cord through your curtain track or rod system.

**06** Sew the curtain tape onto the fabric with a row of stitching on each side of the tape



**09** The hole in the middle of the end hook can be used to hang in a pull bar. To wash your curtain decoration just hang out the hooks, the carrier cord will remain in your track system.



fabric: **art. 11337** col. 0810, curtain tape: **art. 6121** 250%

## Tables for decorations of fabrics with a pattern repeat

art. 6113 uncoated

art. 6122 coated for ironing and easier handling

art. 61130 in col. black

matching glider cords:

art. 14051, 14205, 14067, 14082, 14139, 14186, 14133, 14169 and 14194

distance between **6 cm**

Rule of thumb for an approximate calculation of the needed fabric amount for fabrics **with** a pattern repeat:

**curtain width ÷ 12 x pattern + 30 cm**

Table for a **curtain width of 102 cm**  
(18 gliders)

Table for calculating the fabric amount with pattern repeat			
Table for art. 6113, art. 6122 and art. 61130, distance between 6 cm carrier cord art. 14051, 14205, 14067, 14082, 14139, 14186, 14133, 14169 and 14194			
pattern repeat in cm	fabric width in cm ca.	fabric width in cm (incl. 5 cm on each side for the hem)	fullness in % ca.
40	370	350	343
38	353	333	326
36	336	316	310
34	319	299	293
32	302	282	276
30	285	265	260
28	268	248	243
26	251	231	226
24	234	214	210
22	217	197	193
20	200	180	176

art. 6112 uncoated

art. 6121 coated for ironing and easier handling

art. 61120 in col. black

matching glider cords:

art. 14052, 14206, 14072, 14109, 14140, 14187, 14134, 14170 and 14195

distance between **8 cm**

Rule of thumb for an approximate calculation of the needed fabric amount for fabrics **with** a pattern repeat:

**curtain width ÷ 16 x pattern + 30 cm**

Table for a **curtain width of 104 cm**  
(14 gliders)

Table for calculating the fabric amount with pattern repeat			
Table for art. 6112, art. 6121 and art. 61120 distance between 8 cm carrier cord art. 14052, 14206, 14072, 14109, 14140, 14187, 14134, 14170 and 14195			
pattern repeat in cm	fabric width in cm ca.	fabric width in cm (incl. 5 cm on each side for the hem)	fullness in % ca.
40	290	270	260
38	277	257	247
36	264	244	235
34	251	231	222
32	238	218	210
30	225	205	197
28	212	192	185
26	199	179	172
24	186	166	160
22	173	153	147
20	160	140	135

## II. Sewing instructions for fabrics with a pattern repeat (with vertical stripes or patterns)

**Please take note for coated wave tapes**

When considering to use the coated wave tapes, please take note that art. 6121 and 6122 have an adhesive crystalline coating and were manufactured especially for working with light and transparent fabrics.

You fixate the tapes exactly and evenly with an iron. After that, sewing is no longer a problem. Curtain types such as voile or organza can be brought into a perfect wave form.

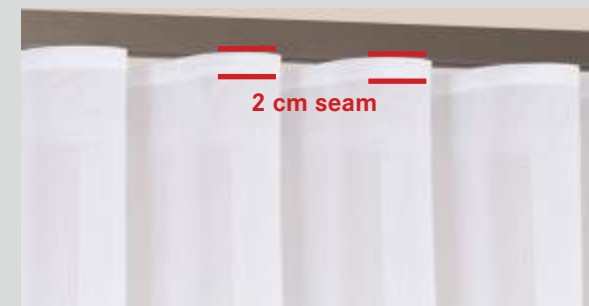

Please remember that with coated tapes the fabric must be slightly turned over the top edge.



**01** Calculate the desired width of your window decoration (in our example the width is approx. 100cm).



**02** Lay the carrier cord (art. 14051) along the desired width.



**03** Count the gliders of the cord and make sure you get an even number so that the curtain will hang in a continuous wave (in our example we use 18 gliders).



**04** Cut the carrier cord.



**07** Add 1/2 of the pleat depth on each side to obtain a continuous curtain wave. In our example 1/2 of the coloured stripe. Then add the seam allowance to identify the cut width.

**05** Calculate the needed fabric amount with the following formula:

$$\frac{\text{amount of gliders}}{2} = \text{amount of pleats (pattern units)}$$

In our example we want the coloured stripes to be in the front. Therefore we now count 9 coloured pattern units. „1“ is the first yellow stripe.

$$18/2 = 9 \text{ pleats (pattern units).}$$



**08** Cut the fabric.

**06** „2“ is the following grey stripe etc. The single-coloured stripes in-between are the pleat depths in this case and remain in the back when the curtain is drawn.

This technique could also be applied to fabrics with a pattern repeat as for example a flower, in this case only count the pattern units with the flowers.



**09** Sew the hem.

Please refer to the tables on page 19.



**10** For the seam, make approximately a 1-cm-fold on each side of the curtain tape and you will have the width of the fabric including the hem.

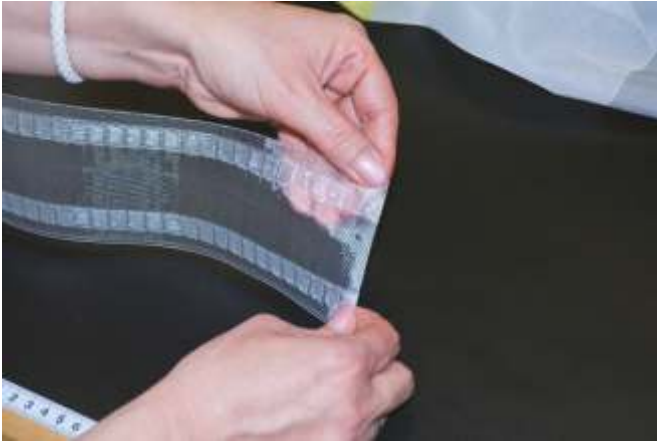

**11** Fold both sides of the curtain tape (1cm each).



**12** For sewing on the curtain tape fold the curtain fabric approx. 2 cm from the top.

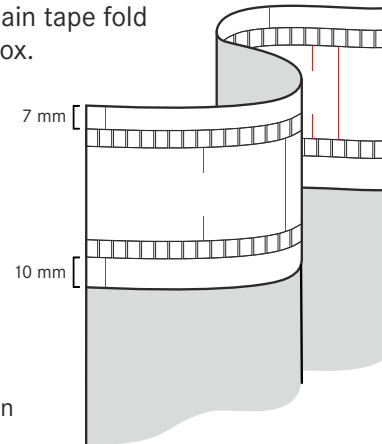

Important: sew on curtain tape **without** a head.



**13** Now sew on the curtain tape at the red line with the folded curtain fabric (see point 12) on both sides of the pockets... at the right side.

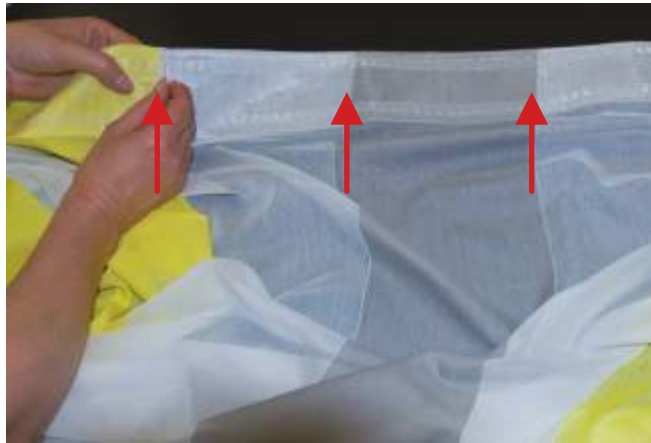

**16** For the pleats to be correct, you need to insert the hooks (art. 14054) in the matching pockets located on the right and left side of the pattern repeat.

The markings are not relevant should you need to add additional fabric without a pattern repeat.

**14** ... and then on the left side!



**17** The middle of the end-hook (art. 14060) needs to be placed correctly at the end of the last pattern repeat. Therefore you need to place the normal hooks in the matching pockets left and right of the end of the last pattern repeat.

**15** The curtain is now complete!



**18** Insert the end-hooks in the first and the last of the gliders of the carrier cord.

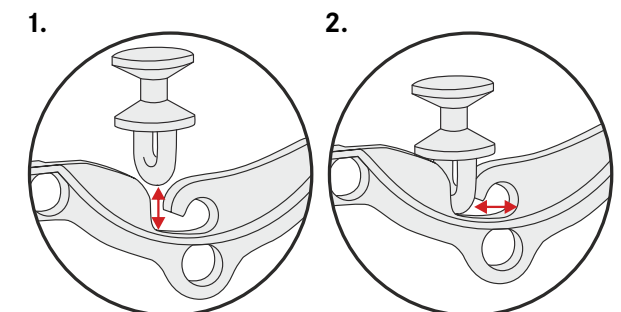



**19** Insert the carrier cord in the curtain rail.



**20** Insert the curtain into the carrier cord starting with the end-hook.



**21** Continue with one glider after another.



**22** Final result will be a visible colored pattern repeat.

**23** If you would like to have the alternative white pattern repeats visible, you need to make sure that you count the white pattern units in point 5.

**24** End result is an example of a finished window decoration.





sheer: **art. 11414** col. 0840, curtain tape: **art. 6112** ca. 200%,  
fabric: **art. 7650** col. 0840, curtain tape: **art. 6121** 280%

One fabric – two designs

Open -



- Close



Effect

Clever  
decoration  
possibilities with the  
**Open - Close Effect**

One fabric – two designs



**Newave the Film**

The ideal way to advertise on your website or in your retail location. Free download in "Mediathek" on [www.gerster.com](http://www.gerster.com). Wave curtains are now extremely trendy. Let your customers get acquainted with the elegance, the function and advantages of this new way to decorate. It will thrill your customers and increase your sales.

NEWAVE

open

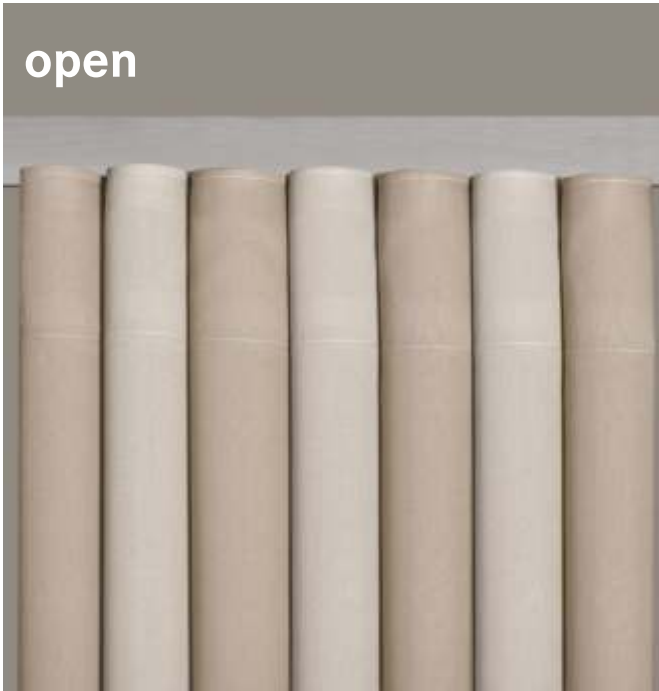

art. 11292 col. 0040

close



3-colors

2-colors



art. 11292 col. 5040





art. 11252 col. 0035



patterned

uni



patterned

patterned



open

art. 11252 col. 0035



close



QUALITY

**Gustav Gerster GmbH & Co. KG**  
Memminger Strasse 18  
88400 Biberach/Riss  
GERMANY



**Vertrieb Deutschland**  
Tel.: 07351 586-500  
Fax: 07351 586-5400  
verkauf@gerster.com

**Worldwide Sales**  
Tel.: +49 7351 586-501  
Fax: +49 7351 586-5408  
export@gerster.com

[www.gerster.com](http://www.gerster.com)

sheer: **art. 11427** col. 0010, Ccurtain tape: **art. 6112** 250%